



DOSATRON®

WATER POWERED DOSING TECHNOLOGY

D25RE09-11GPM Rebuild Kit

Kit # MKD25RE09



This kit contains:

(1) JDI106	Plunger Seal
(1) J024	Graduated Sleeve O-ring
(1) JDI098	Injection Stem O-ring
(1) PJDI026	Check Valve Assembly
(2) M238	Actuator Springs
(1) P421	Piston Shell

GENUINE
DOSATRON
PARTS



LIT-EN-MKD25RE09

MKD25RE09 Instructions

Part 1 - Seal Kit

(Parts included in kit noted in **blue**)

1. Remove the 4 screws (M101) at base of the unit. Pull dosing stem straight out to remove.

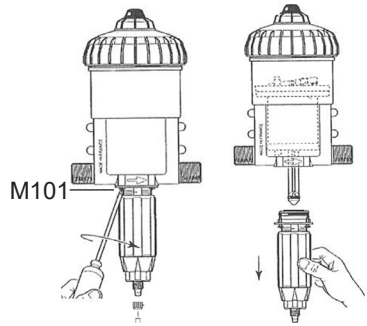

2. Unscrew the suction hose nut (PDI038) and check valve nut (PDI036). Pull out the check valve assembly (**PJDI026**) noting orientation of inner check valve cone with spring.

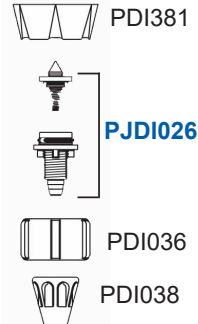

3. Unscrew locking nut (PDI381) and remove locking ring (P189). Remove black adjusting sleeve (P167U1) and metal mounting collar (M079).

Push firmly from below to release inner white stem (PDI583) from graduated sleeve (P165).

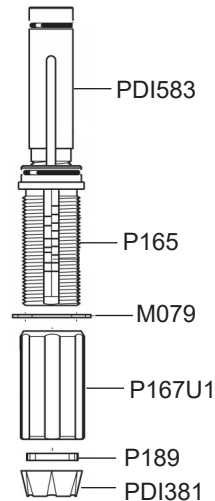

4. Pinch and remove injection stem o-ring (**JD1098**) from white stem (PDI583) and replace with new o-ring.

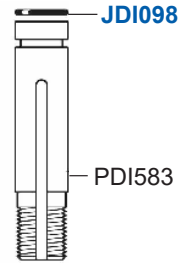

5. Pinch to remove and replace the graduated sleeve o-ring (**J024**) from the graduated sleeve (P165).

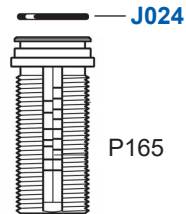

6. Insert the injection stem (PDI583) into the top of the graduated sleeve (P165). Push firmly down on injection stem as far as it will go.

Make sure the long groove in the injection stem aligns with the tooth inside the graduated sleeve.

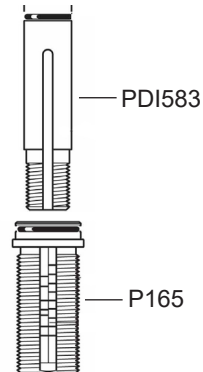

7. Slide metal mounting collar (M079) over graduated sleeve (P165) and injection stem (PDI583).

Screw adjusting sleeve back onto graduated sleeve (P165) enough to expose locking ring grooves in lower, threaded area of injection stem (PDI583).

Align inner teeth on locking ring (P189) with exposed grooves on lower injection stem (PDI583) and slide up grooves to the base of adjusting sleeve (P167U1).

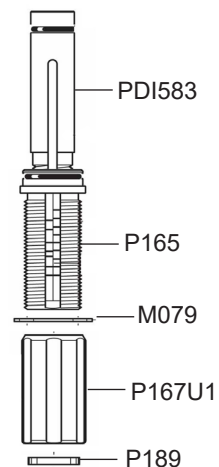

8. Screw locking nut (PDI381) back onto injection stem assembly.

Insert new check valve assembly (**PJDI026**) noting orientation of inner check valve cone with spring into exposed injection stem.

Screw on the check valve nut (PDI036) and replace suction hose nut (PDI038).

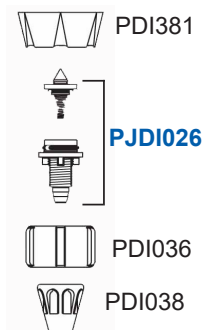

9. Pinch the plunger seal to remove it and replace with the new plunger seal (**JDI106**).

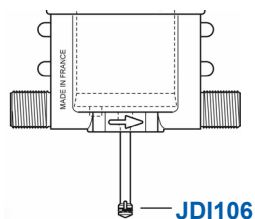

10. Align the ratio guide to the front and reinsert injection stem assembly.

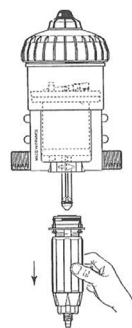

11. Align the metal collar (M079) with the holes in the body. Install the four screws using a #2 Phillips screw driver.

Remove suction hose nut (PDI038) and reattach suction hose onto check valve barb.

Reattach suction hose nut (PDI038).

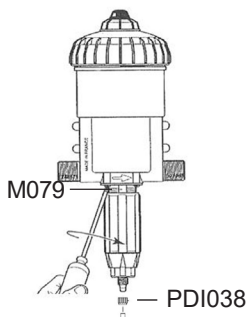

To ensure hose is air-tight, you may choose to carefully cut the top of hose before reinserting.

MKD25RE09 Instructions

Part 2 - Piston Kit

(Parts included in kit noted in **blue**)

1. Remove the blue lid.
2. Lift piston from unit.
3. Remove screw (8M003) and wishbone holder (P394) from wishbone valve assembly (MP178). Slide inlet valve out from its secure clip-on wishbone assembly (MP178).
4. Remove the 4 screws from the middle of the shell. The mechanism will drop out.
5. Remove the **Actuator Springs (M238)** and replace.
6. Replace the mechanism into new **Piston Shell (P421)**.
Make sure to tighten screws while holding mechanism from below to ensure a secure, flush fit against inside surface of piston shell (P421).
7. Clip wishbone assembly (MP178) back into its proper position on top of inlet valve. Secure back of wishbone assembly by installing wishbone holder (P394) and securing with screw (8M003).

