



DOSATRON®

Because life is powered by water®

**Download our
DOSATRON
app**



 **App Store**

 **Google play**

MANUFACTURED BY

DOSATRON INTERNATIONAL S.A.S.

Certified QEH&S System

Rue Pascal - B.P. 6 - 33370 TRESSES (BORDEAUX) - FRANCE

Tel. 33 (0)5 57 97 11 11

Fax. 33 (0)5 57 97 11 29 / 33 (0)5 57 97 10 85

info@dosatron.com - www.dosatron.com

© DOSATRON INTERNATIONAL S.A.S 2020



NTSD25ALN-EN-11-20



DOSATRON[®]

Because life is powered by water[®]



User manual

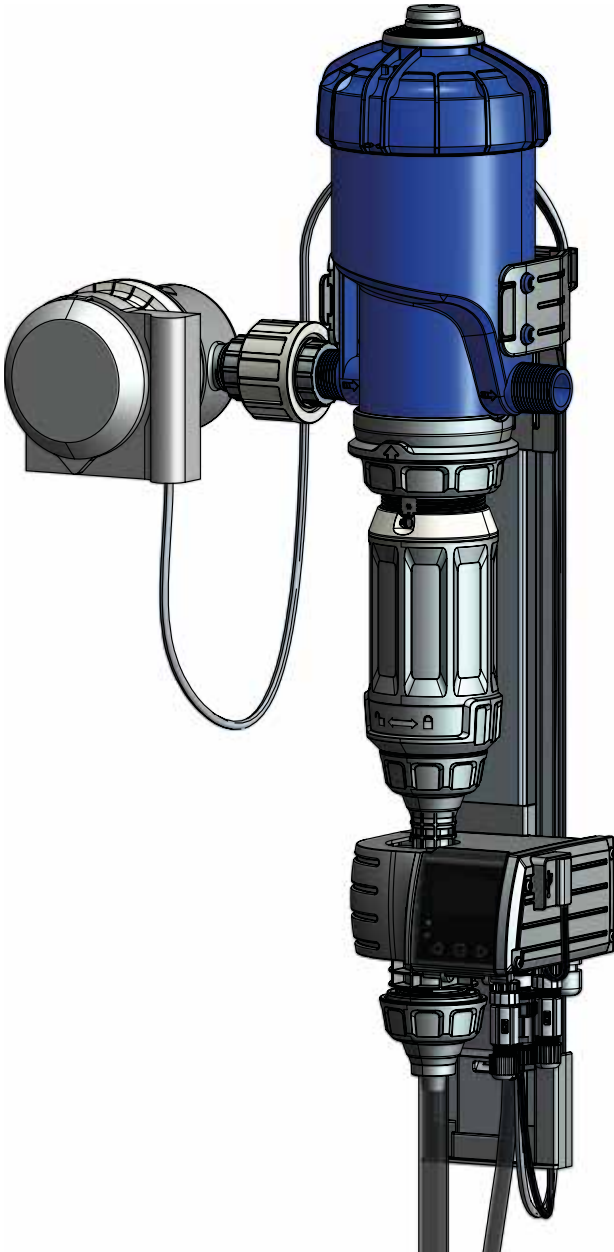

SD25ALN - ANIMAL HEALTH LINE

English

This document does not form a contractual engagement and is for information purposes only. DOSATRON INTERNATIONAL reserves the right to modify its devices at any time.

© DOSATRON INTERNATIONAL S.A.S 2020

Congratulations on your choice.

This model has been developed on the strength of over 45 years of experience.

Our engineers have developed the DOSATRON series to become one of the most technically advanced water-powered dosing pumps in the world.

This DOSATRON will, in time, reveal itself to be a most faithful ally.

A few regular maintenance operations will guarantee you operation in which the word “failure” will no longer be heard.

**THEREFORE PLEASE READ THIS MANUAL CAREFULLY
BEFORE USING THE DEVICE**

Important!

You will find your DOSATRON's part number and serial number on the pump body.

Please record these numbers in the space provided below for easy referral when contacting or requesting information from your seller.

Ref: SD

Serial No.:

Date of purchase:

Contents

MARKINGS / IDENTIFICATION / SPECIFICATIONS

| | |
|--|---|
| Codification of the reference | 8 |
| Electrical technical specifications of the monitoring system | 8 |
| Electrical power supply | 8 |
| Fuses..... | 8 |
| Dimensions, weight and package contents..... | 8 |

INSTALLATION

| | |
|---|----|
| Recommendations | 9 |
| The SD25AL5N SmartDosing System | 10 |
| Identifying your Dosatron | 11 |
| Terminal board input and output features | 12 |
| Installing the SmartDosing system..... | 14 |
| Dosing pump installation - Mounting bracket - Monitoring..... | 16 |
| Connecting the motor cycle sensor..... | 17 |
| Connecting the pulse water meter | 18 |
| Connecting the suction hose and level detection pipe..... | 19 |
| Farming type installation (overview)..... | 20 |

STARTING AND SETTING UP SMARTDOSING

| | |
|--|----|
| Presentation of the monitoring system..... | 21 |
| Starting the monitoring system..... | 22 |
| Navigation features | 23 |
| Language settings | 23 |
| Setting up the type of farming installation..... | 23 |
| Setting up the number of rooms / water lines / pens | 24 |
| Setting up the units | 25 |
| Setting the time/date | 25 |
| Setting the eco mode | 25 |
| Setting up the No Water Consumption Alarm - Vaccination / V..... | 25 |
| Setting up the No Water Consumption Alarm - Other Treatments..... | 26 |
| Setting up the Low Tank Level Alarm..... | 26 |
| Activating remote alarms (connecting to an external alarm box) | 26 |
| Dosing scale indexing | 27 |
| Information communication (MODBUS)..... | 28 |

| | |
|--|----|
| Information software version (FIRMWARE) | 28 |
| FEATURES: TREATMENTS | |
| Recording treatments | 29 |
| Starting a treatment..... | 29 |
| Blank test..... | 32 |
| End of the treatment and summary..... | 33 |
| FEATURES: ALARMS | |
| Alarms table | 35 |
| FEATURES: INFORMATION AND HISTORY | |
| Treatment history..... | 39 |
| Pump history | 40 |
| FEATURES: DIAGNOSIS | 41 |
| RETRIEVING RECORDS | |
| Via a USB key | 43 |
| Via the converter cable | 43 |
| SMARTDOSING CONNECTIVITY | |
| Connecting to an alarm relay | 43 |
| Connecting to a computer with the supplied converter cable | 43 |
| Communication settings (MODBUS)..... | 46 |
| Connecting to a house controller | 46 |
| INSTALLING THE SMARTLINK SOFTWARE | |
| Requirements prior to installation..... | 47 |
| SmartLink installation | 47 |
| When connecting to a computer | 52 |
| STARTING AND SETTING UP SMARTLINK | |
| Features and use | 57 |
| Settings | 64 |
| UPDATES | |
| SmartDosing updates..... | 65 |
| SmartLink updates | 66 |
| MAINTENANCE | 67 |
| TROUBLESHOOTING | 69 |
| WARRANTY | 71 |

Markings / Identification Specifications

Our system has 3 main marking locations for easy and detailed identification:

1. The device's specific part number and serial number are engraved in two lines along the edge of the pump body (see image below).
2. A technical label on each side of the dosing pump indicating its part number, serial number and technical data.
3. A technical label on the monitoring part of the system indicating the model name and serial number.

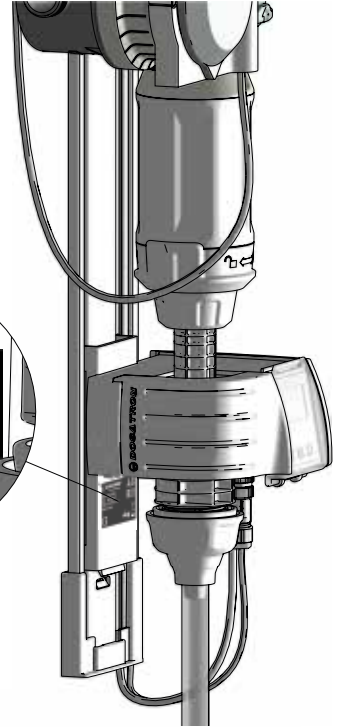

REF.
Serial No.

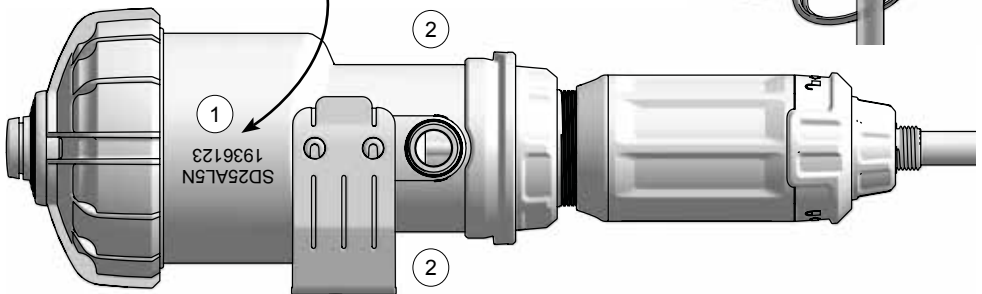

*** Group 1 Definition**

Group 1 devices: Group 1 includes all devices that are not classified as Group 2 devices.

Group 2 devices: Group 2 includes all radio-electric frequency ISM (industrial, scientific and medical) devices in which radio-electric frequency energy in the frequency range 9 kHz to 400 GHz is intentionally generated and used, or used only in the form of electromagnetic radiation, inductively and/or capacitively coupled, for examinations or analyses or for the treatment of matter.

CODIFICATION OF THE REFERENCE

REF. : Serial No.:

| | | | | | |
|---------|------|----|---|---|----|
| Example | SD25 | AL | 5 | N | VF |
|---------|------|----|---|---|----|

Dosatron range

Product line - AL: Animal Health Line

Max. dosing in %

Certification - N: Food compatibility

Dosing Seal type - VF: Rather acid additives (pH 0 to 9)

ELECTRICAL TECHNICAL SPECIFICATIONS OF THE MONITORING SYSTEM

Device Class: Class B

Device Group: Group 1*

Supply voltage: 12-24V DC, 130-70 mA

Frequency [Hz]: See power supply

Monitoring protection class: IP55

Monitoring insulation class: Class III equipment

Power surge category: 2

Pollution level: 2

ELECTRICAL POWER SUPPLY

Supply voltage fluctuation: 110 V-AC: $\pm 10\%$ - 230 V-AC: $\pm 10\%$

Power Cable (AC Adapter):

Input: - 110 V-AC or 230 V-AC power supply
- Frequency range: 50/60Hz

Outlet: - Output voltage: 12 V-DC $\pm 5\%$

- Maximum power output: 19.2 W
- Maximum noise level 150 mV

Outlet power surge & overcurrent protection

Batteries: This device is equipped with a CR2032 lithium battery (for RTC backup). This device is also equipped with a 9V - 6LR61 back-up battery in case of a general power failure.

FUSES

Size: 5x20 mm. Specifications: current: 250 mA - maximum permissible current: 1,500 A.

Speed: fast (F), High breaking capacity type H - 1,500 A

DIMENSIONS, WEIGHT AND PACKAGE CONTENTS

Package size : 53 x 35 x 18 cm

Package weight : 4.52 kg

SmartDosing equipment: 1 monitoring unit / 1 dosing pump mounting bracket / 1 water meter / 1 level detection pipe / 1 pipe guide / 1 measuring cylinder for diagnosis / 1 start-up manual / 1 USB key / 1 RS485-USB communication cable & 1 quick connector / 1 power supply & 5 plugs / 1 pulse transmitter & 1 motor cycle sensor

Installation

RECOMMENDATIONS

- The mains power connection must be carried out by qualified personnel in accordance with local regulations.
- Ensure that the connection to the system's electrical supply is protected against water projections.
- Keep the DOSATRON system away from significant heat sources and protect it from freezing in winter.
- Only the operator is responsible for correctly selecting the system settings.
- The SmartDosing system's suction hose or level detection pipe should be replaced as soon as they show signs of damage from the dosed concentrated product.
- The system must be switched off after use.

WARNING

During installation, operation and maintenance of the DOSATRON SmartDosing system, the following safety instructions must be respected: use suitable tools, protective clothing and safety goggles when working on the equipment and install it in such a way as to ensure risk-free operation.

Follow the instructions in this manual and take safety measures appropriate to the nature of the liquid additives and the water temperature. Be extremely cautious in the presence of dangerous substances (corrosive, toxic, dissolving, acids, caustic substances, inflammable substances, etc.).

The SmartDosing system must be installed, connected to the various sub-assemblies and maintained with the power off and the water supply circuit closed.

All electrical connections and wiring must comply with local building standards.

 **WARNING! The personnel in charge of installing, operating and maintaining this equipment must be fully acquainted with the contents of this manual.**

 **WARNING! Always ensure that the USB cover is closed to keep the case watertight.**

- Be sure to make regular backups of the monitoring system and SmartLink data.
 - The SmartDosing and SmartLink software should be periodically updated.
 - Do not cut the level detection pipe
- Connecting the system to a power outlet does not recharge the 9 V battery. The USB port should not be used with any hardware other than a USB key.

INSTALLATION LOCATION

- The DOSATRON and the dosing additive must be accessible at all times. Their installation must under no circumstances present a pollution or contamination risk.
- Try to position the SmartDosing water by-pass pipe work in such a way that the SmartDosing is high enough to enable easy reading of the screen and menus (flexible water connections such as stainless-steel braid types may be used).
- The device is to be installed inside a technical room or house.
- The unit must be installed in a vertical position on a horizontal pipe.
- The SmartDosing system cannot be positioned more than 30m from the power source.

The following installation requirements must be taken into account:

- Altitude: Less than 2,000m
- Ambient temperature: 5°C/40°C
- Relative humidity: 20% - 80%

SERVICE

- This SmartDosing device was tested before being packaged.
- Repair sub-assemblies and seal pouches are available upon request.
- Do not hesitate to call your distributor or DOSATRON for any after-sales services.

SD25AL5N SMARTDOSING SYSTEM

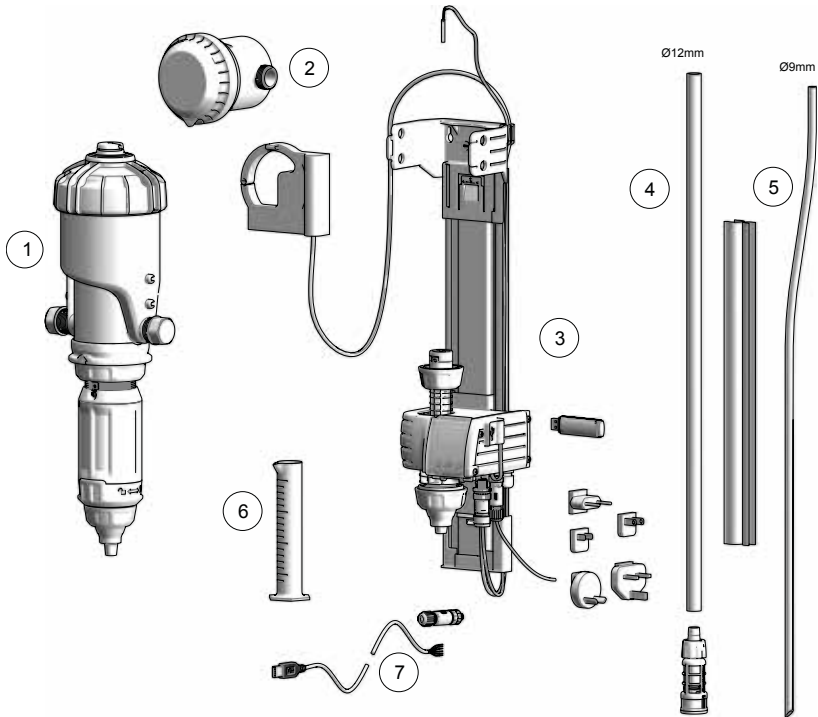

- 1 DOSATRON D25AL5N proportional hydraulic dosing pump equipped with a motor cycle sensor
- 2 Water meter with IZAR PULSE® pulse transmitter
- 3 Dosing pump mounting bracket with monitoring unit
- 4 Suction hose and strainer
- 5 "Level detection" pipe and pipe guide
- 6 Test tube for diagnosis
- 7 RS485-USB communication cable and quick connector

IDENTIFYING YOUR DOSATRON

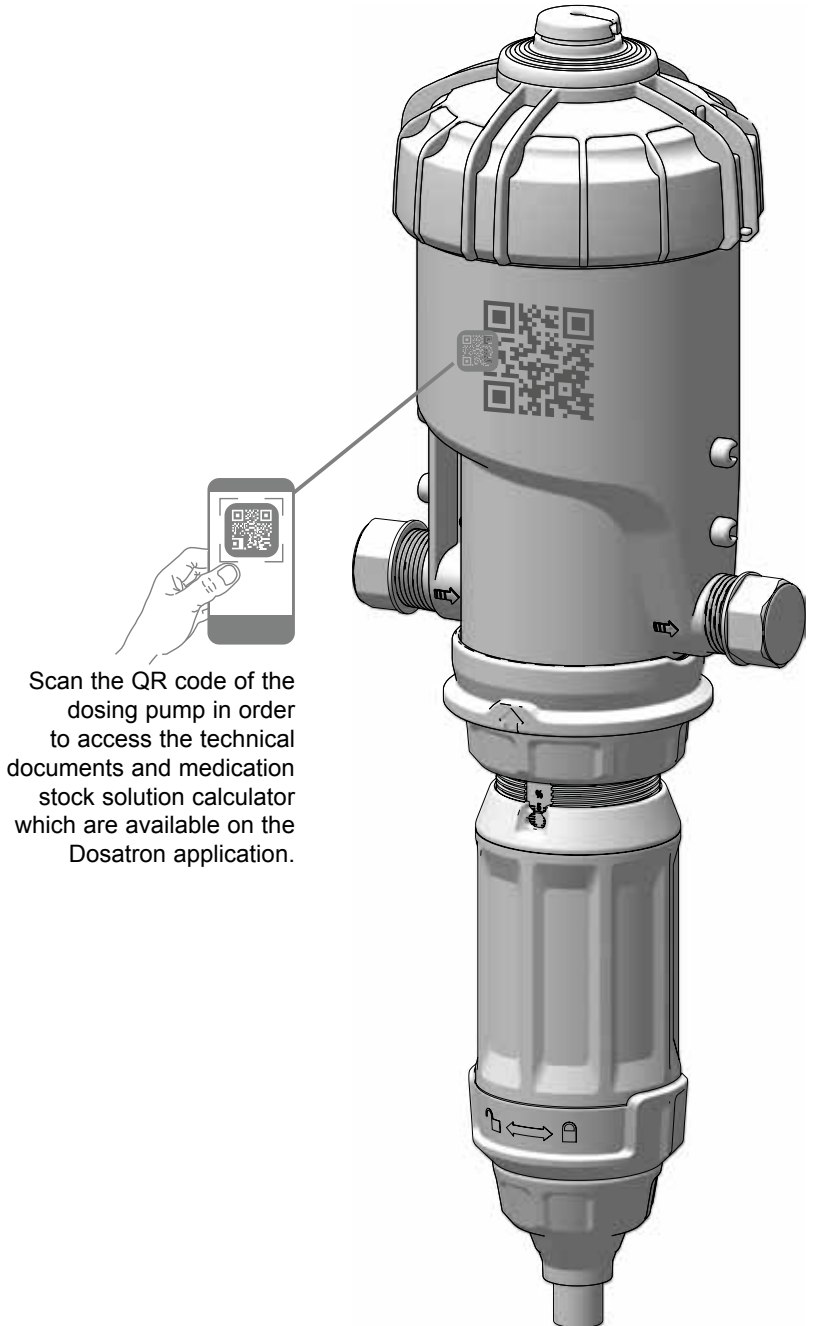

TERMINAL BOARD INPUT AND OUTPUT FEATURES

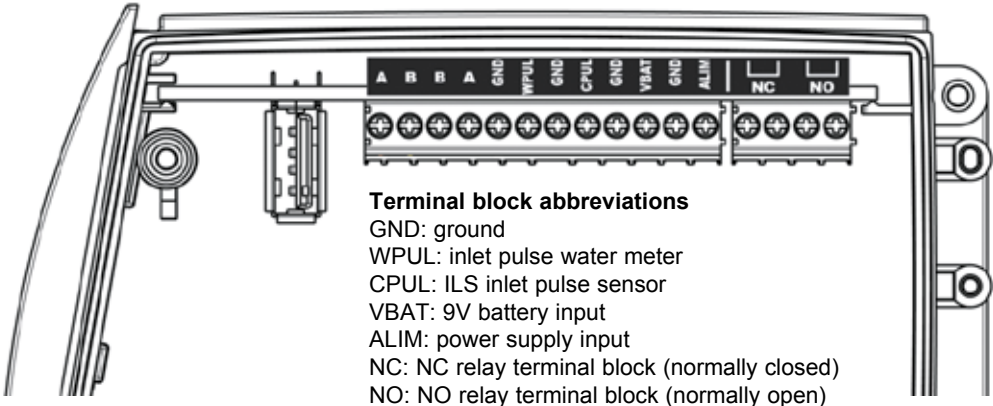

NC / NO OUTPUT TERMINALS:

Relay outputs which are simultaneously activated when one of the alarms and events programmed on the SmartDosing is selected (See STARTING AND SETTING UP SMARTDOSING).

The circuits connected to the relay contacts must be Very Low Voltage (VLV).

It is not possible to connect to mains voltage type 230 Vac.

Maximum power: 60V DC or 30V AC, maximum current: 2 A.

The more limiting of the two.

VBAT/GND TERMINALS (9 V BACK-UP BATTERY)

The SmartDosing device is equipped with a 9V alkaline back-up battery to enable the operator to switch off the product as normal in the event of a mains power failure.

If this is a frequent occurrence, the battery should be replaced more often (see MAINTENANCE).

When replacing the battery, it is advisable to use the same ANSMANN

9 Vdc - 500 mAh battery, model 6LR61.

It is connected to the VBAT and GND terminals

A/B/B/A/GND TERMINALS

Output for an RS485 MODBUS connection in accordance with the EIA TIA 485 standard

 **The RS485 connected circuit must not leave the building in which the SmartDosing device is installed (the circuit is not considered as TRT1)**

USB PORT

The USB port can be accessed by opening the cover marked with a USB symbol.

The USB port only works with a USB key for transferring data and firmware updates

Under no circumstances can this USB port be used to power another device.

INSTALLING THE SMARTDOSING SYSTEM

The power cable includes 5 different plugs to adapt to any type of electrical outlet. Simply choose the plug that suits your country and connect it to the power supply.

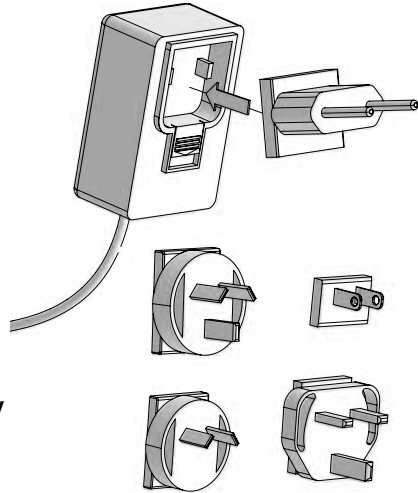

To isolate the device, the power supply must be unplugged from the mains.

⚠ The wall socket must be freely accessible and its location must allow it to be disconnected from the electrical network at any time. To disconnect the appliance from the power supply, unplug from the wall socket.

The device's power supply unit must be positioned away from possible splashes and/or be protected by a watertight casing.

Sensors: the motor cycle counter and water meter pulse transmitter must be connected to the monitoring system, as well as the SmartDosing power supply.

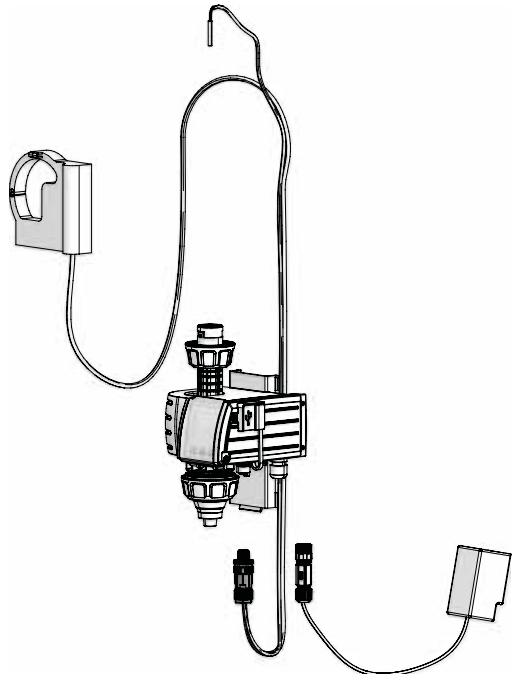

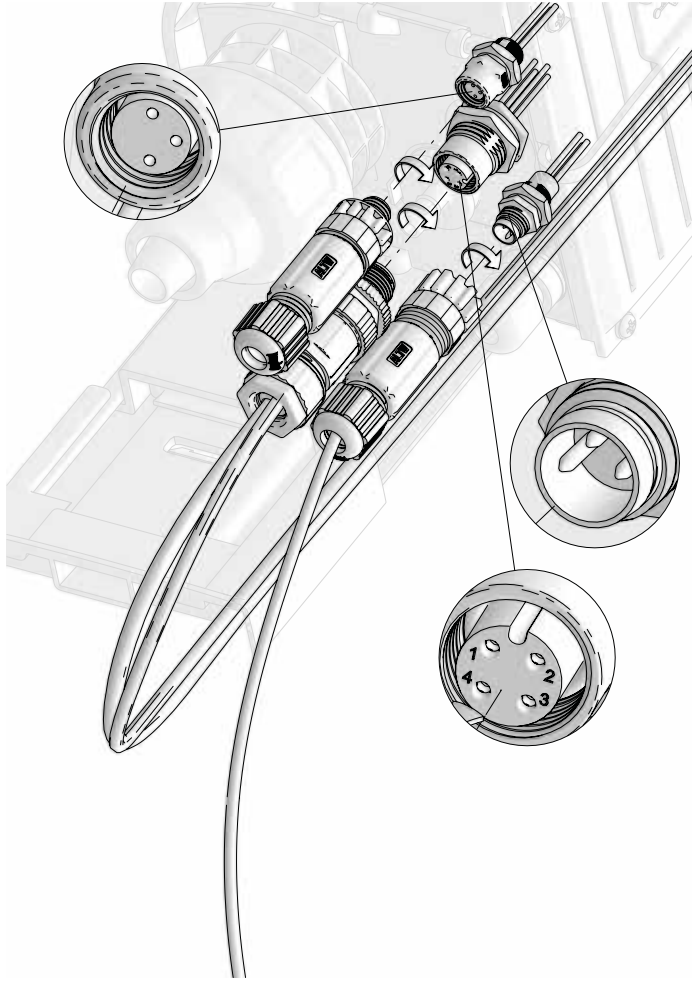

To do this:

- locate the position of each cable to be connected on the monitoring system
- remove the caps from the quick connectors
- position the locating pin and screw each quick connector into the monitoring system

When connecting the RS485-USB communication cable to its quick connector, please refer to the CONNECTIVITY section

DOSING PUMP INSTALLATION - MOUNTING BRACKET - MONITORING

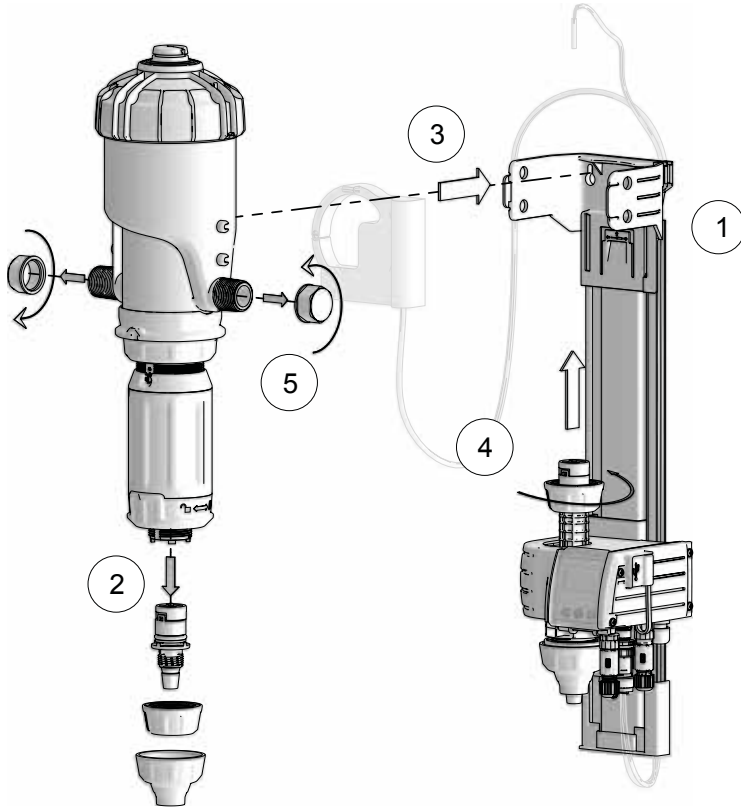

① Install the dosing pump mounting bracket with the monitoring sub-assembly

⚠ Attach the mounting bracket to the wall at a height where the monitoring sub-assembly screen is easy to read and use.

② Remove the dosing pump's hose connection (store safely for after sales purposes).

③ Insert and position the dosing pump in the mounting bracket by slightly spreading the support arms so that the 4 lugs located on the pump's main body engage correctly in the corresponding holes on the mounting bracket.

④ Connect the monitoring module via the hole provided in the dosing pump's hose connection.

⑤ Remove the dosing pump inlet and outlet protective caps.

⚠ Be careful when removing the protective caps; all dosing pumps are factory tested and may contain water! Make sure that the USB cover is properly closed before removing the caps. Always make sure that the USB cover is closed to keep the case watertight. Check that the water flows in the direction of the arrow on the dosing pump.

CONNECTING THE MOTOR CYCLE SENSOR

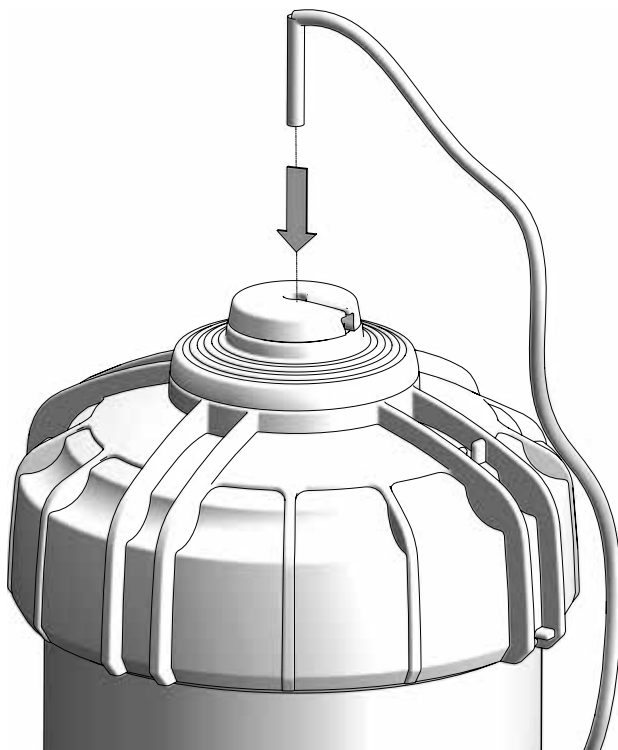

Insert the motor cycle sensor assembly into the centre of the motor lid and insert the cable through the bleed slots and the motor lid.

CONNECTING THE PULSE WATER METER

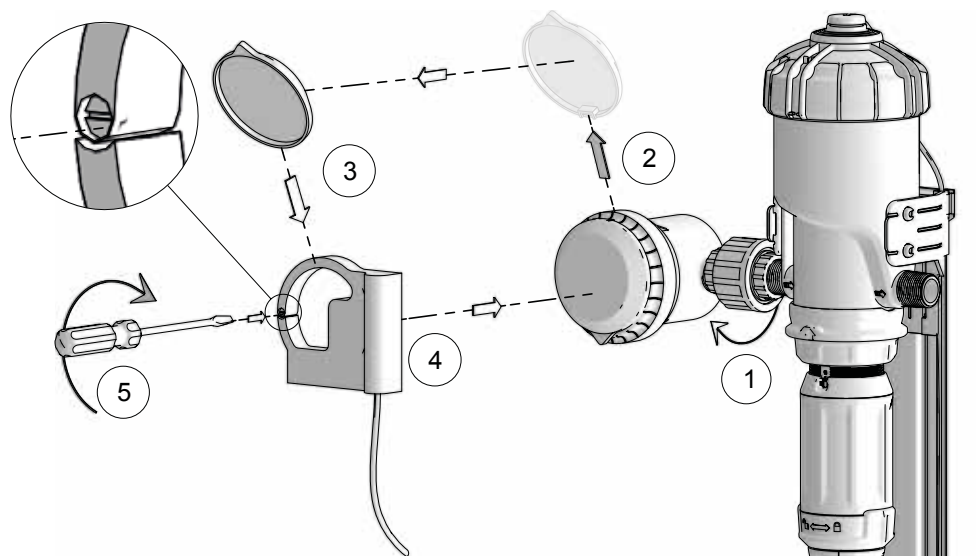

- 1 Connect the water meter to the dosing pump inlet.

⚠ Make sure that the water flows in the same direction as the arrow on the meter.

- 2 Unclip the water meter cover.
- 3 Place the water meter cover on the pulse transmitter.
- 4 Position the IZAR PULSE® pulse transmitter by aligning the cover hinges with one another. Click into place by pressing the ring on the module, using only your hands.
- 5 Position the pulse transmitter clamping screw to «|».

CONNECTING THE SUCTION HOSE AND LEVEL DETECTION PIPE

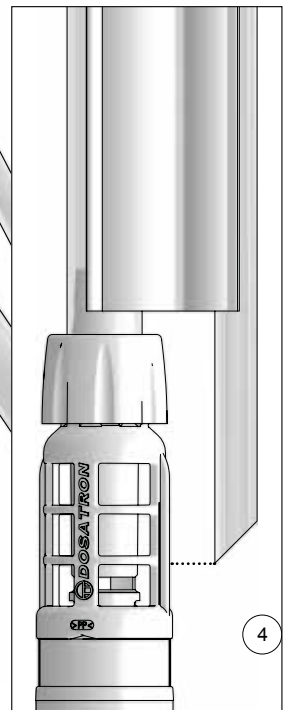
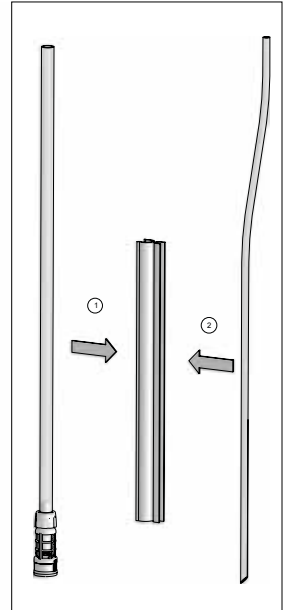
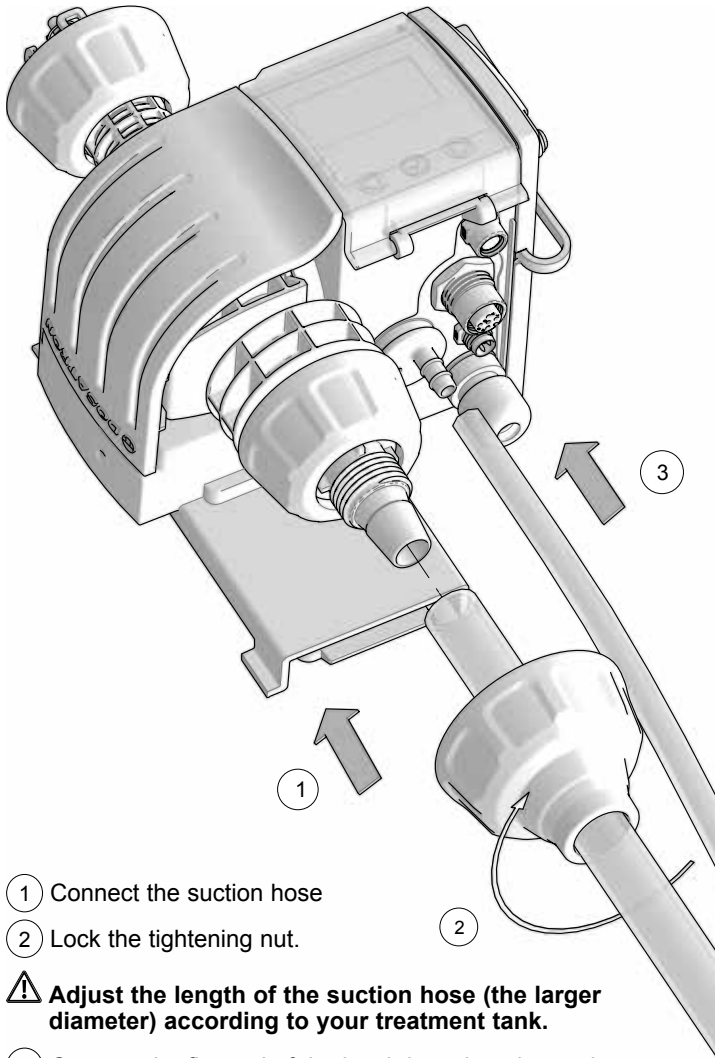

① Connect the suction hose

② Lock the tightening nut.

⚠ **Adjust the length of the suction hose (the larger diameter) according to your treatment tank.**

③ Connect the flat end of the level detection pipe to the monitoring module.

⚠ **Do not cut the level detection pipe (the smaller diameter)**

④ Connect the two hoses using the hose guide by adjusting the bevelled side of the level detection pipe opposite the suction inlet base in the strainer at the correct height (see diagram for positioning the level detection pipe in relation to the suction strainer).

FARMING TYPE INSTALLATION (overview)

For installations using potable water, please respect the standards and regulations in force in your country.

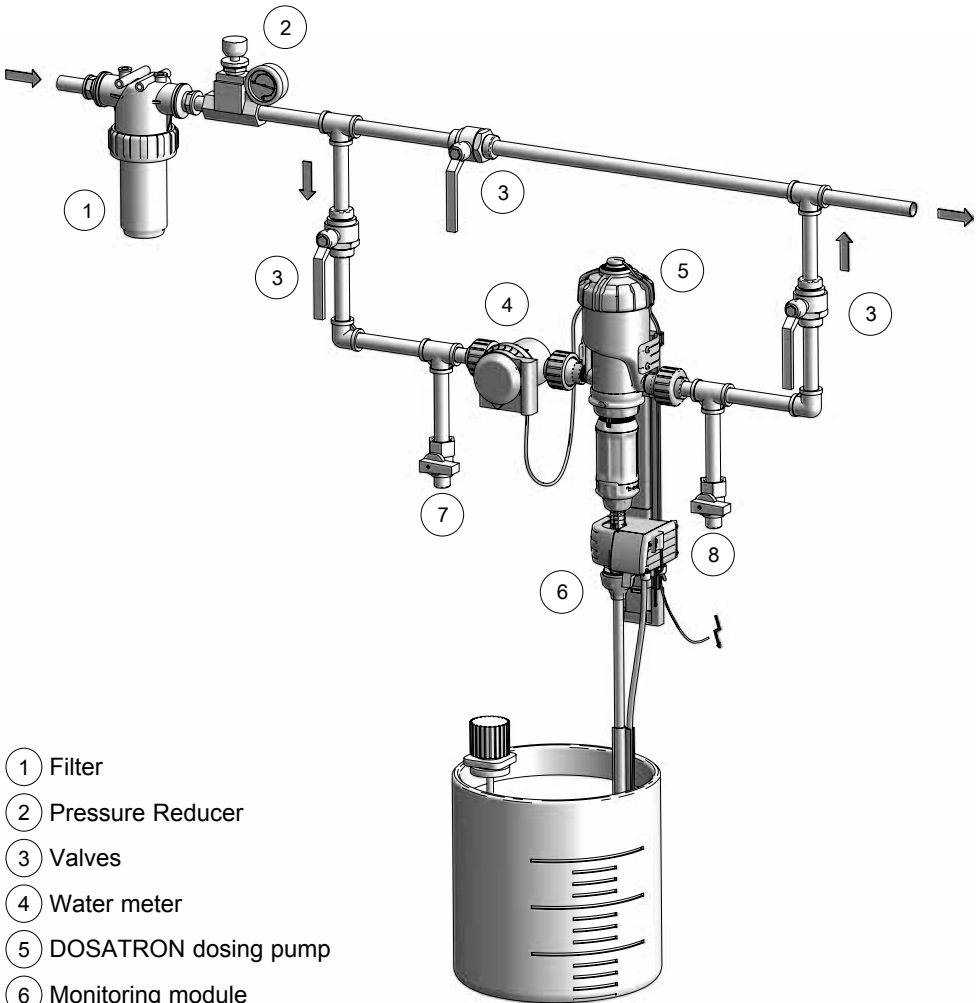

- ① Filter
- ② Pressure Reducer
- ③ Valves
- ④ Water meter
- ⑤ DOSATRON dosing pump
- ⑥ Monitoring module
- ⑦ Clear water valve:
preparing stock
solutions & tank rinsing
- ⑧ Fast priming valve /
rinsing / Dosatron testing /
Diagnosis

Starting and setting up SmartDosing

PRESENTATION OF THE MONITORING SYSTEM

- ① User interface screen
- ② Green LED - treatment recording indicator
- ③ Red LED - incident indicator
- ④ Validation and on/off button
- ⑤ Navigation buttons
- ⑥ USB port

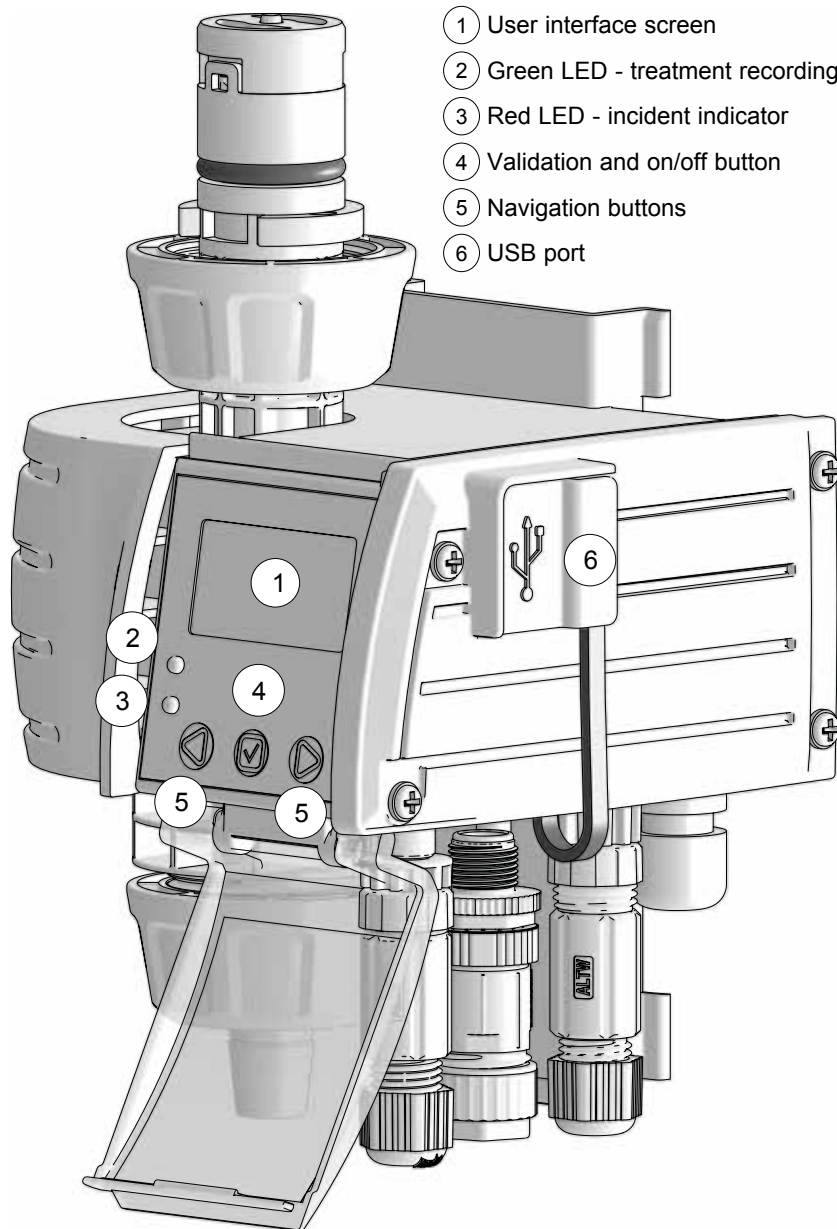

STARTING THE MONITORING SYSTEM

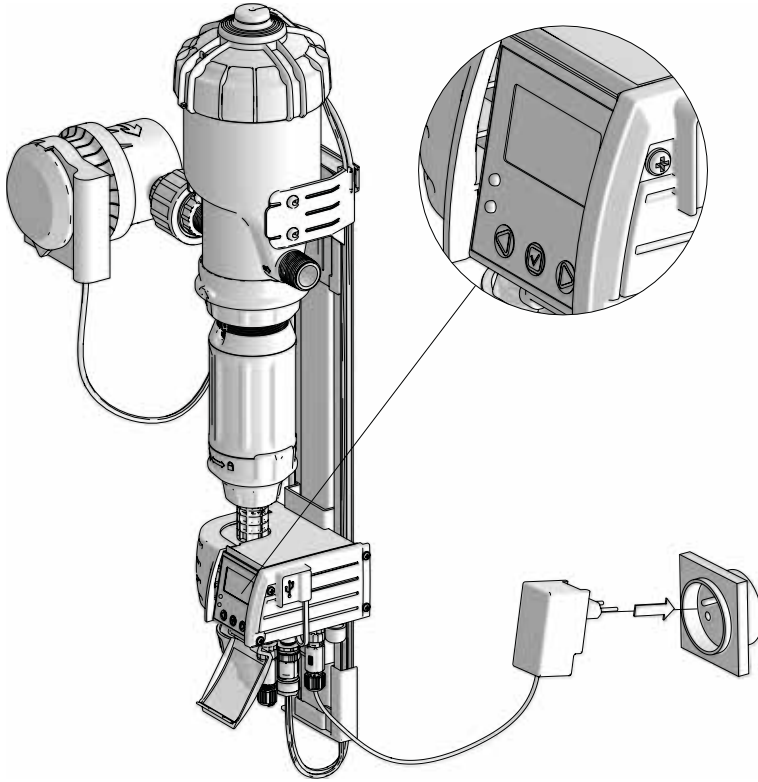

1 - Connect the AC adapter to the mains power supply before switching on the device.

2 - Press the  button (for 1 second) to start the monitoring system and access the home screen.

SD25AL5N 3.0%
29/04/2019
10:48

3 - Press the  button again to access the main menu.

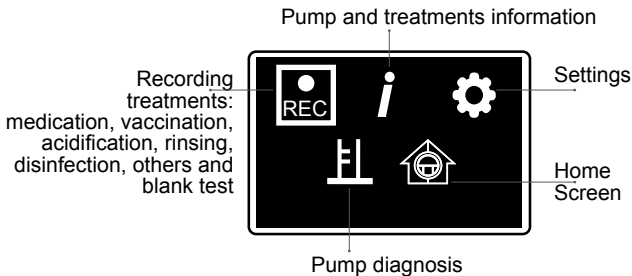

NAVIGATION FEATURES

The monitoring validation button is used to confirm the selections made, for example, selecting a language during setup, as well as to launch a treatment.

The monitoring system's ◀ and ▶ navigation buttons allow you to navigate through the menus and confirm the action proposed on the screen above each button.

On the interface screen, the ◀ or ▶ arrows allow you to navigate within the same menu or sub-menu, while the back arrow ↶ allows you to return to the next higher menu or sub-menu.



LANGUAGE SETTINGS

In the MAIN menu, press the ◀ or ▶ navigation buttons to select the SETTINGS  menu and confirm

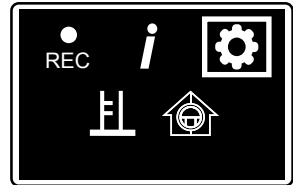

The LANGUAGE sub-menu appears. To change the language, press



Press ▶ until you reach the desired language, then

SETTING UP THE TYPE OF FARMING INSTALLATION

In the SETTINGS menu , press the ◀ or ▶ navigation buttons to select the SPECIES sub-menu, then .
This setting must be entered the first time you use the device.

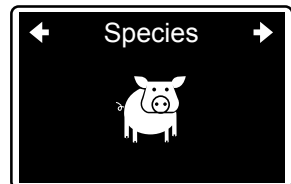
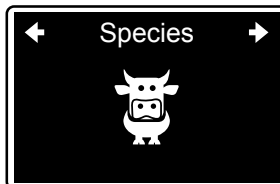
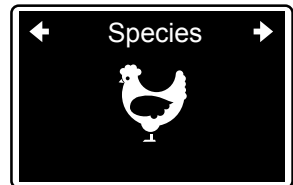

Press ► until you reach the desired farming installation, then ☑

SETTING UP THE NUMBER OF ROOMS/WATER LINES/PENS

In the SETTINGS menu ⚙, press the ◀ or ▶ navigation buttons to select the ROOMS, WATER LINES or PENS sub-menu depending on the type of farming previously selected, then ☑



Press ► until you reach the number of rooms/water lines/pens subsequent to the SmartDosing device, then ☑



You can select up to 20 rooms/water lines/pens.

Rooms/water lines/pens are numbered by default from 1 to the required number.

To rename them, press ► to the next screen and then ☑

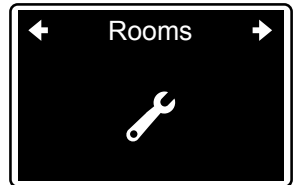

Select each rooms/water lines/pens to be renamed and then ☑

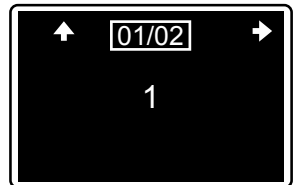

You must enter a maximum of 3 characters to name each rooms/water lines/pens.

Press ► until you reach the desired letter or number for the first character, then ☑



Repeat the operation for the other 2 remaining characters and then



Repeat this for each rooms/water lines/pens.

SETTING UP THE UNITS

In the SETTINGS menu , press the ◀ or ▶ navigation buttons to select the UNITS sub-menu, then
Press ▶ until you reach the desired unit, then

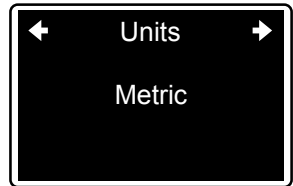

SETTING THE TIME/DATE

In the SETTINGS menu , press the ◀ or ▶ navigation buttons to select the DATE/HOUR sub-menu, then
To set the date and time, use the ◀ and ▶ navigation arrows, validating each choice.
For entering the date, refer to the legend to select the order of the day/month/year values.



SETTING THE ECO MODE

Eco mode switches the SmartDosing screen to standby mode when it has been idle for a certain period of time, which is identified when setting up for the first time.

In the SETTINGS menu , press ◀ or ▶ to select the ECO MODE sub-menu, then
Press ▶ until you reach the desired period, then

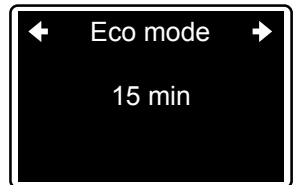

It is recommended that you switch off the SmartDosing device when not in use to preserve the life of the display.

SETTING UP THE NO WATER CONSUMPTION ALARM - VACCINATION / V

The non-consumption alarm triggers an alert in the event that your animals do not consume water for a long period of time or in the event of a water supply problem (mains failure, clogged filter, etc.).

The default limit for a vaccination is 10 minutes.
This limit can be set according to the normal amount of time your animals go without drinking.

In the SETTINGS menu , press ◀ or ▶ to select the NO WATER CONSUMPTION - VACCINATION / V sub-menu, then
Press ▶ until you reach the desired limit, then

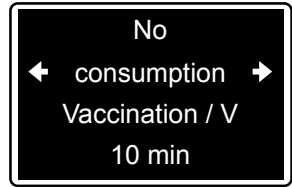

SETTING UP THE NO WATER CONSUMPTION ALARM - OTHER TREATMENTS

The default limit for all treatments other than vaccination is 1 hour. This limit can be set according to the normal amount of time your animals go without drinking.

In the SETTINGS menu , press ◀ or ▶ to select the NO WATER CONSUMPTION - OTHER TREATMENTS sub-menu, then
Press ▶ until you reach the desired limit, then

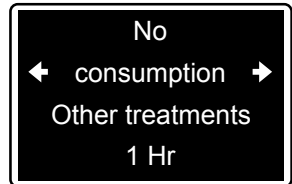

SETTING UP THE LOW TANK LEVEL ALARM

The low level alarm triggers an alert when the treatment level in the tank falls below the limit established during the initial setup.

In the SETTINGS menu , press ◀ or ▶ to select the LOW LEVEL sub-menu, then
Press ▶ until you reach the desired limit, then

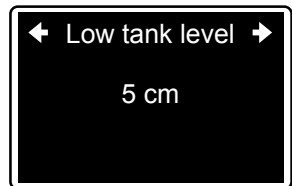

ACTIVATING REMOTE ALARMS (CONNECTING TO AN EXTERNAL ALARM BOX)

The SmartDosing device features the following alarms: empty tank, motor stop, injection stop, backflow, overflow, no consumption and low tank level.

Activating remote alarms allows one or more of these alarms to be sent to an external alerting device, such as a telephone or a visual alerting device.

In the SETTINGS menu ⚙️, press ◀ or ▶ to select the REMOTE ALARM ACTIVATION sub-menu, then ☑

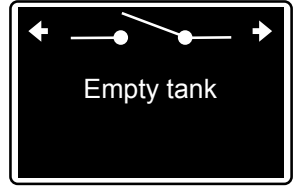

Press ▶ until you reach the desired alarm, then press ☑ to activate it: the remote alarm is then activated and its name is underlined.

Press ☑ again to deactivate the remote alarm; the name will no longer be underlined.

Connecting your box to an alarm relay is described in the CONNECTIVITY section.

DOSING SCALE INDEXING

⚠️ WARNING

Dosing scale indexing must be performed before using the SmartDosing device for the first time, after each disassembly/reassembly of the dosing pump system or when instructed by a service technician for maintenance purposes. This means confirming the dosing pump index scale with the SmartDosing settings.

The dosing adjustment must be carried out with no pressure in the system. No tools should be used.

In the SETTINGS menu ⚙️, press ◀ or ▶ to select the INDEXING sub-menu, then ☑

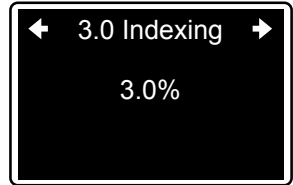

- 1 Shut off the water supply and reduce the pressure to zero, then loosen the locking ring
- 2 Screw or unscrew the adjusting sleeve to align the top of the sleeve with the required dosing mark
- 3 Tighten the locking ring

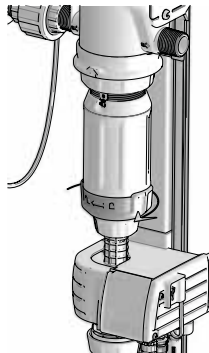

1

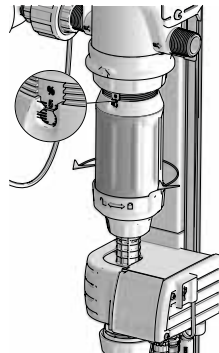

2

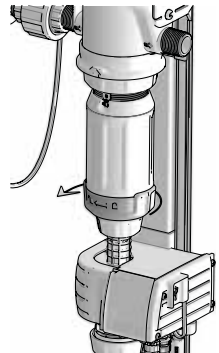

3

Once the dosing pump has been adjusted to the required value, confirm by clicking

When the arrows move to the up position on the screen, the indexing is complete.

INFORMATION COMMUNICATION (MODBUS)

SmartDosing can be connected to other systems (house controller, computer, etc.) by using the MODBUS communication mode.

This information is used to communicate between 2 devices as described in the CONNECTIVITY section.

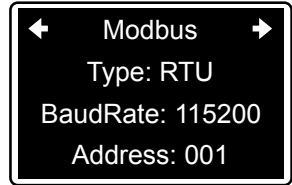

Connecting your box is described in the CONNECTIVITY section.

INFORMATION SOFTWARE VERSION (FIRMWARE)

The last screen of the SETTINGS menu provides information concerning the monitoring module software along with the details of your SmartDosing device. A technician may ask you for this information as part of a maintenance operation.

In the SETTINGS menu , click on ◀ or ▶ to view the software version, serial number and monitoring module model. Press the right arrow to return to the main menu.

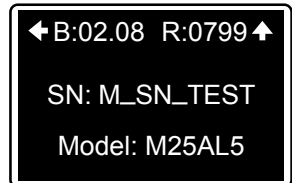

You should regularly update your SmartDosing device's embedded software as described in the UPDATES section.

Features: treatments

RECORDING TREATMENTS

The SmartDosing system allows you to record the treatments carried out with the DOSATRON device: the volume of water treated, the volume of treatment injected and the duration of the treatment carried out.

The available treatment types are:

- Medication
- Vaccination
- Acidification
- Rinsing
- Disinfection
- Others
- Blank test

⚠ Before you begin recording a treatment, you should consider the following:

- **Estimate the amount of water consumed by the animals per treatment period.**
- **Set the dosing percentage on the dosing scale of the Dosatron pump.**
- **Rinse the dosing pump and tank thoroughly to remove any residues.**
- **Prepare the required amount of stock solution, if applicable.**
- **Open the Dosatron by-pass valves and close the water inlet valve.**

You can use the Dosatron medication calculator on your SmartLink software or via the Dosatron application to help you prepare the solution in the medicine tank.

Download our
DOSATRON
app



STARTING A TREATMENT

In the monitoring MAIN menu, press
◀ or ▶ to select the RECORD menu, then

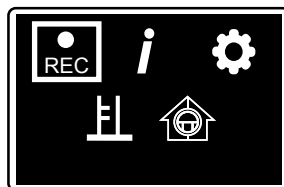

Press ► until you reach the desired treatment, then ☑

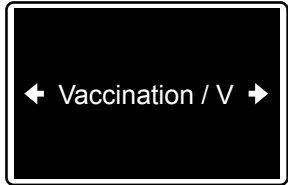

If, during setup, you have entered the names of several rooms/ water lines/pens:
Select the rooms/water lines/pens to be treated using ◀ or ▶ and confirm ☑. When the name is underlined, the room/water line/pen is selected.
Return to OK and press ☑ to confirm the selection.

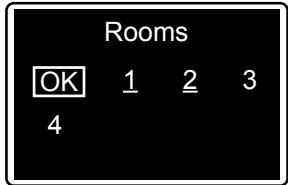

If the species is poultry, you can indicate the water withdrawal period (non-drinking period) prior to the vaccination.
Press ☑ to confirm the selection.

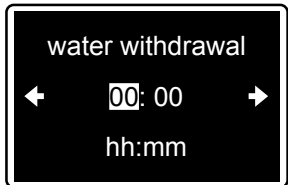

⚠ WARNING:
At this stage and before recording any treatment, you must initialise the tank level sensor in order to ensure the accuracy of the measurement. To do so, simply shake the 2 hoses to remove any residual liquid in the small pipe of the level sensor.

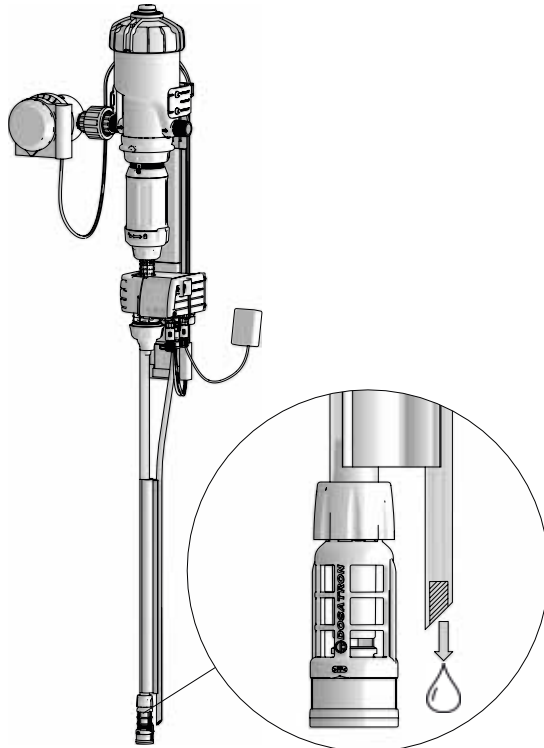

- If it is submerged, raise the level sensor to remove any liquid that may have accumulated inside. Reposition it in the tank.
 - Fill the tank with the previously calculated amount of stock solution.
 Press to confirm.



During a vaccination, once you have filled the stock solution tank, the system will prompt you to prime the drinking pipes until the blue dye mixed with the vaccine solution reaches the drinkers. The system will then account for the amount used to prime the system.

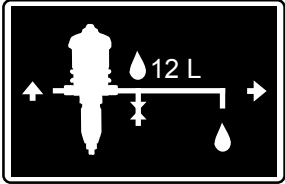



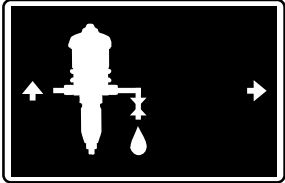

For any other treatment, once you have filled the stock solution tank, the system will prompt you to prime the dosing pump until the suction hose is filled.





Once the operation is complete, press to confirm and to record the treatment.

While recording is in progress, the recording dashboard will be displayed and the green LED will light up. It will only switch off when it has finished recording (tank empty or manual stop).

Amount of treated water —  1.738 L  — Type of treatment being recorded

Amount of treatment injected —  0.052 L 

Length of treatment —  0D 00H 00M 20

Press  to access the 2nd dashboard screen displaying the treated rooms/water lines/pens.

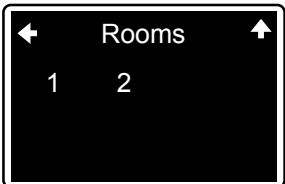

Press the navigation button corresponding to the ► arrow on the screen to return to the MAIN menu while continuing treatment.

To return to the current treatment's dashboard, select the RECORDING menu from the MAIN menu.

BLANK TEST

A blank test enables you to schedule a recording in order to determine your animals' consumption on a chosen date and for a given period of time.

In the monitoring MAIN menu, press ◀ or ▶ to select the RECORD menu, then ☑

Press ▶ until you reach the desired treatment, then ☑



If, during setup, you have entered the names of several halls/ circuits/enclosures:
Select the hall(s)/circuit(s)/enclosure(s) to be tested using ◀ or ▶ and confirm ☑. When the name is underlined, the hall/circuit/ enclosure is selected.
Return to OK and press ☑ to confirm the selection.

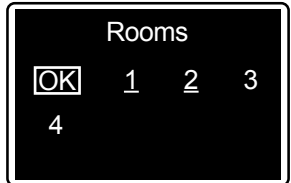

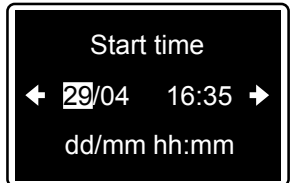

Once you have selected the rooms/water lines/pens to be tested, enter the recording start date and time. If you wish to start straight away, simply confirm the displayed information.

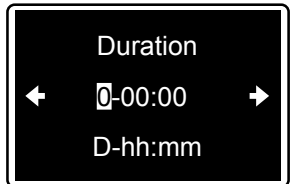

Fill in the recording time.

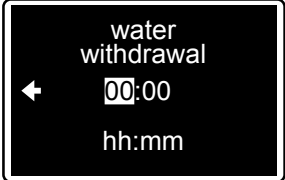
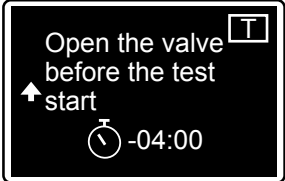
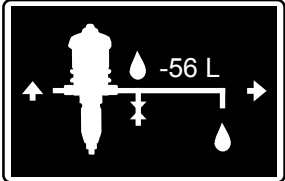

| | |
|---|--|
| <p>If the species is poultry, you can indicate the drinking water withdrawal period prior to the vaccination.</p> |  |
| <p>Fill the tank with clear water and open the water valve to feed the pump. A countdown timer will indicate how much time is left before the scheduled recording starts. Make sure that the valves supplying the rooms/water lines/pens that have been selected for the blank test are open.</p> |  |
| <p>The recording will stop once the predetermined duration has elapsed. You can use the summary screen to determine the amounts required for the next treatment.</p> | |
| <h2 style="background-color: black; color: white; padding: 5px;">END OF THE TREATMENT AND SUMMARY</h2> | |
| <p>Treatment recording will stop in the following cases:</p> <ul style="list-style-type: none"> - Empty tank (see the ALARM FEATURES section) - Voluntary manual shutdown. - Switching off the system. | |
| <p>During vaccination, when the tank is empty, the recording will not stop until the initially recorded priming volume of the water circuits has been entirely consumed by the animals.</p> |  |
| <p>To stop a treatment manually, go back to the recording dashboard and press <input checked="" type="checkbox"/></p> |  |
| <p>When the treatment recording stops, the treatment summary will be displayed.</p> | |
| <p>If you see this screen, then there is a difference of more than 10% between the water meter and the motor cycle counter. In such cases, you should run a diagnosis using the measuring cylinder (see the DIAGNOSIS FEATURES section).</p> |  |

If the treatment is to be repeated following a veterinary prescription, the volume summary screen will be displayed once again. You can then prepare your stock solution for the next day based on your animals' consumption of the previous day.

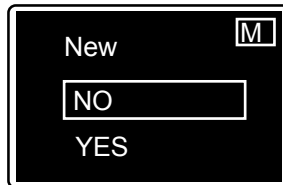

(E.g.: 5 records for 5 consecutive days of medication).

Renewal is not available for VACCINATION treatments.

⚠ A summary of the last 15 treatments can also be accessed via a shortcut in the INFORMATION menu (see the INFORMATION AND HISTORY FEATURES section).

Features: alarms

Alarms are only active in the REC recording mode.

In the event of an alarm, a warning screen is systematically displayed by hiding the screen in use and the red LED begins to flash.

Press to acknowledge the alarm and return to the screen in use.

For most alarms, the screen reappears 4 minutes after the alarm has been acknowledged and the red LED will flash once again if the problem is not resolved.

If an alarm has been triggered but is no longer active, the red indicator light will remain constantly lit and the alarm display will remain on the screen.

Press to acknowledge the alarm and return to the screen in use.

ALARMS TABLE

EMPTY TANK

The SmartDosing system indicates when the tank is empty, which will automatically end the recording.

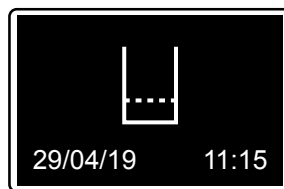

The date and time of the empty tank will appear on the display.

The display is automatically cleared by stopping the recording.

⚠ If a vaccination was recorded at the start of the treatment, the circuit priming volume will have been recorded. In this case, the recording will stop automatically when the empty tank sensor reaches its limit, which is adjusted according to the recorded priming volume of the water circuits.

LOW TANK LEVEL

The SmartDosing system indicates when the tank is almost empty.

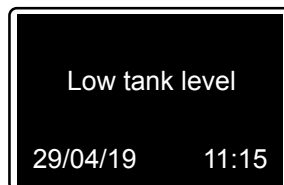

This is the maximum level of solution in the tank (in cm) before the alarm is triggered. This limit can be adjusted in the SETTINGS menu (see STARTING AND SETTING UP SMARTDOSING)

Press to acknowledge the alarm and return to the screen in use.

BACKFLOW ALARM

The SmartDosing system indicates an abnormal increase of the treatment level in the tank.

Example: the pump's two suction valves leaking at the same time, pumping water into the tank, or the tank being filled by the operator during a treatment.



Press to acknowledge the alarm and return to the screen in use.

If the alarm is activated repeatedly, perform a diagnosis using the measuring cylinder (see the DIAGNOSIS FEATURES section).

OVERFLOW ALARM

The SmartDosing system indicates when the dosing pump has exceeded the maximum flow rate of the Dosatron pump for more than 5 consecutive seconds.

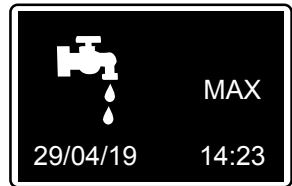

Press to acknowledge the alarm and return to the screen in use.

If the alarm occurs repeatedly, check your device's flow rates.
(It may be that the Dosatron dosing pump model you have chosen is too small in relation to the actual water flow rates/volumes required for your farm)

MOTOR STOP ALARM

The water circulates, the water meter detects the flow rate, but the SmartDosing system indicates that the dosing pump's motor has stopped: no signal is detected by the motor cycle sensor located on the lid (this is an indication of small internal leaks caused by pump motor wear).



Number of times the alarm is triggered during a treatment

Volume of water detected by the water meter without receiving a signal from the motor cycle counter

Date and time that the alarm started

This alarm appears if, during the course of the vaccination, the water meter detects more than 5 l of continuous water flow with no detection signal from the motor cycle counter. The limit for other treatments is 20 l.

Press to acknowledge the alarm and return to the screen in use.

If the alarm sounds repeatedly, perform a diagnosis using the pump's measuring cylinder to determine whether the motor part is OK or is in need of maintenance. (see the DIAGNOSIS FEATURES section).

NO WATER CONSUMPTION ALARM

Not consuming water may be related to your animals' normal behaviour (consuming less at night for example) or could be due to a water supply problem (closed valve, main water supply failure, blocked filter, etc.).



Number of times the alarm is triggered during a treatment

Date and time that the alarm started

Length of time with no water consumption

The SmartDosing system indicates that the REC function is active, but the water meter and motor cycle counter have not detected a flow rate for a period of time exceeding the pre-selected time limit (see STARTING AND SETTING UP SMARTDOSING).

Press to acknowledge the alarm and return to the screen in use.

If the alarm occurs repeatedly, check your device's filters and the animals' normal consumption. If you don't find any problems, you can increase the alarm time limit. The patterns from previous SmartLink records (the displayed water consumption records) can help you determine this limit.

PREVENTIVE MAINTENANCE ALARM

The SmartDosing system indicates when the injection seals may need replacing, based on the total volume of water that has passed through the pump, even without treatment. This information is provided as a rough guide, since specific factors such as the type of dosing additives, the water quality and especially how often the pump is rinsed after use can extend or reduce the service life of the seals.

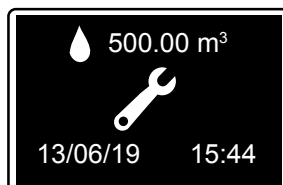

Tip! The DIAGNOSIS menu can be used to check the performance of the dosing assembly.

Go to the SETTINGS  menu to acknowledge the alarm once the required maintenance has been carried out.

Press  until you reach the MAINTENANCE sub-menu, then

Press again to acknowledge the alarm.

BATTERY ALARM

The SmartDosing system is equipped with a 9 V battery which allows the monitoring system to operate during small power cuts in the main power supply. The battery may need to be replaced more often if this is a regular occurrence.

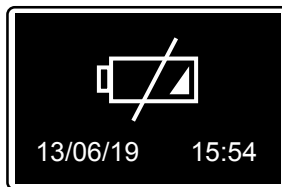

The “low battery” alarm indicates that the remaining battery life is less than 1 hour, and that the battery should be replaced. See MAINTENANCE

Press to acknowledge the alarm and return to the screen in use.

INJECTION STOP ALARM

The SmartDosing system detects when the dosing pump no longer injects the additive as it should (may be due to a problem with the injection assembly plunger seal or the strainer being completely clogged with non-dissolved additives). As soon as this alarm sounds, the injected additive will not be counted up until the end of the treatment (tank empty or manual stop).



If this alarm appears, you should check the strainer, the general condition of the suction tube and the correct position of the level detection pipe in relation to the strainer or the plunger seal. Recommendation: Perform a diagnosis using the measuring cylinder (see the DIAGNOSIS FEATURES section).

Press to acknowledge the alarm and return to the screen in use.

Features: information and history

The SmartDosing system provides access to the last 15 recorded treatments and the Dosatron pump's performance history.

In the MAIN menu, press the ◀ or ▶ navigation buttons to select the INFORMATION menu and confirm

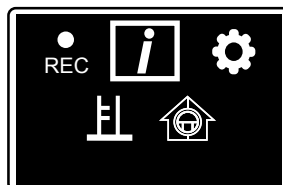

You can use the SmartLink data processing software to access more treatments and further details.

TREATMENT HISTORY

Select the TREATMENT HISTORY sub-menu, then . To return to the previous screen, use the navigation button which corresponds to the back arrow ↶.

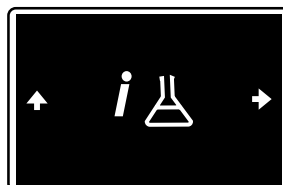

 A screenshot of a treatment summary screen. It displays the following information:

- Top left: Information icon 'i' and flask icon.
- Top center: A box containing '01/15' with left and right navigation arrows.
- Top right: Label 'Numbering of the last 15 treatments' with a line pointing to the '01/15' box.
- Middle left: Label 'Treatment start date and time' with a line pointing to '29/04/19'.
- Middle center: '29/04/19' and '14:23'.
- Middle right: Label 'Reminder of the treatment label' with a line pointing to 'A'.

Press ▶ until you reach the desired treatment, then

The treatment summary will be displayed.

 A screenshot of a detailed treatment summary screen. It displays the following information:

- Top left: Label 'Start date and time' with a line pointing to '29/04/19'.
- Top center: '29/04/19' and '14:23'.
- Top right: Label 'End date and time' with a line pointing to '29/04/19'.
- Middle left: Label 'Duration' with a line pointing to a clock icon.
- Middle center: '0D00H03M'.

Press ▶ to access the second information screen.

Reason for
stopping treatment:
empty tank or
manual stop

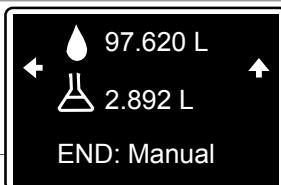

Volume of treated
water

Volume of
treatment injected

Press to go back to the previous menu.

PUMP HISTORY

The SmartDosing system provides access to the Dosatron pump's performance history.

In the MAIN menu, press the or navigation buttons to select the INFORMATION menu and confirm

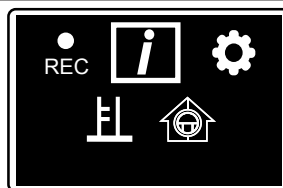

Press or to select the PUMP HISTORY sub-menu, and then confirm .

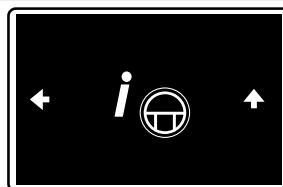

The 1st screen displays the volume of water that has passed through the dosing pump and the estimated volume of treatment injected over the last 24 hours.

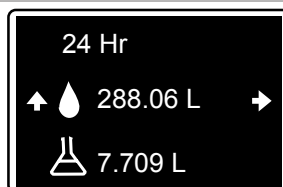

Press to access information about the installation date.

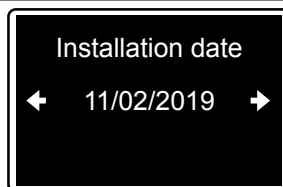

Press to access the total meter values, as well as information concerning the running time, the total volume of water that has passed through the pump (treated and untreated water), and the total volume of treatment (estimated total volume) injected since the installation.

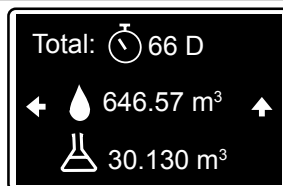

Press to go back to the previous menu.

Features: diagnosis

The SmartDosing system allows you to compare the dosing pump's performance with the factory data, using a measuring cylinder and the water meter.

⚠ The suction hose must be primed before starting the diagnosis procedure.

In the MAIN menu, press the ◀ or ▶ navigation buttons to select the DIAGNOSIS menu, and then confirm

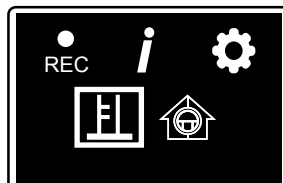

The CLOSE THE VALVE screen is automatically displayed: you should close the valve which supplies the dosing pump.

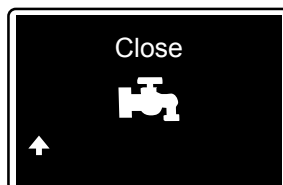

After 10 seconds, the SET UP screen will appear: manually set the dosing scale to the required percentage.



The red LED remains on, and the dosing value flashes until the selected value is reached. (if the expected value cannot be reached, index the dosage as described in the DOSAGE INDEXING section).

When the dosing pump reaches the required value, the dosing value will stop flashing and the red LED will turn off. The next screen will appear automatically.





The FILL THE TEST TUBE screen is displayed:

- Place the suction hose strainer with the level sensor hose in the measuring cylinder.
- Fill the measuring cylinder above 500 ml.
- Make sure that the dosing pump's suction hose is properly filled before starting the self-diagnosis program.

TIP: Use the priming valve located after the Dosatron device to prime the suction hose.

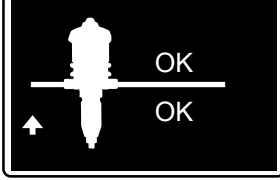
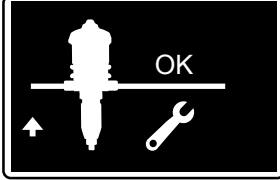
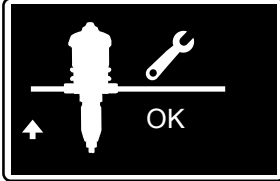
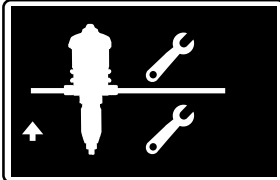

| | |
|---|--|
| <p>The OPEN THE VALVE screen is displayed: open the dosing pump's inlet valve, to activate the motor, and the bleed valve located after the dosing unit in order to provide a sufficient flow of water for the diagnosis.</p> |  |
| <p>The CYCLES screen appears. The dosing pump's cycle count is reset, and automatically counted down to 0. The results of the motor and dosing sub-assembly's diagnosis are then automatically displayed.</p> |  |
| <p>- Case 1: motor and dosing sub-assembly OK.</p> |  |
| <p>- Case 2: motor OK, dosing sub-assembly in need of maintenance.</p> |  |
| <p>- Case 3: motor in need of maintenance (internal leaks), sub-assembly OK.</p> |  |
| <p>- Case 4: motor and sub-assembly in need of maintenance.</p> |  |

Retrieving records

VIA A USB KEY

Insert the USB key in the slot on the right side of the device; the data transfer screen will appear automatically.

Select the **DOWNLOAD** icon, (this transfers the monitoring data to the USB key) use the ◀ or ▶ buttons if needed, and then to start downloading.

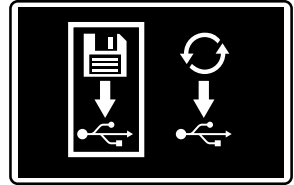

The **ONGOING PROCESS** screen appears automatically.

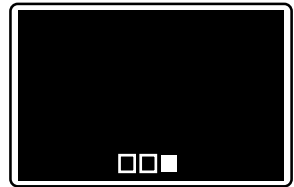

When the USB download is complete, the initial screen will be displayed. The USB key can now be removed.

VIA THE CONVERTER CABLE

Recordings are retrieved automatically depending on the converter cable's settings (See **INSTALLING THE SMARTLINK SOFTWARE**)

SmartDosing Connectivity

SmartDosing data can be recovered directly from your PLC or computer, by connecting to the terminal board.

CONNECTING TO AN ALARM RELAY

When connecting to an alarm relay, the following requirements must be met (see **PRESENTATION OF THE SMARTDOSING SYSTEM**)

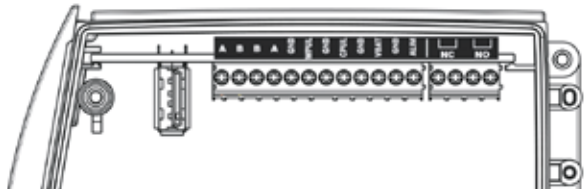

Depending on your alarm relay, connect to the terminal board via the NC or NO outputs.

CONNECTING TO A COMPUTER with the supplied converter

You have been provided with a 5m long RS485 USB communication cable and a quick connector to connect to your computer.

If this length is sufficient:

- remove the cap from the quick connector at the front of the monitoring system
- connect the communication cable to the quick connector making sure that the wires are positioned as shown in the diagram below
- position the locating pin and screw the quick connector into the monitoring system

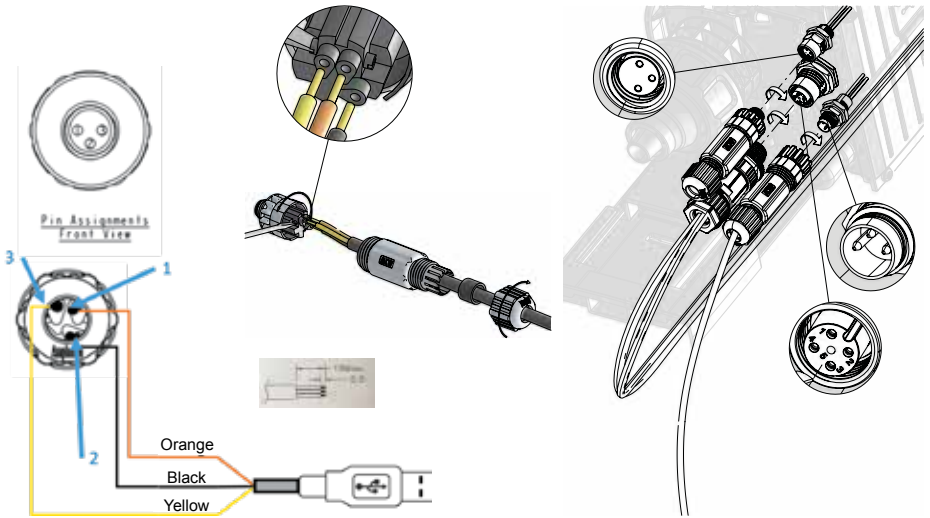

Connect the converter cable directly to a USB port on your computer and follow the installation procedure described in the INSTALLING THE SMARTLINK SOFTWARE section.

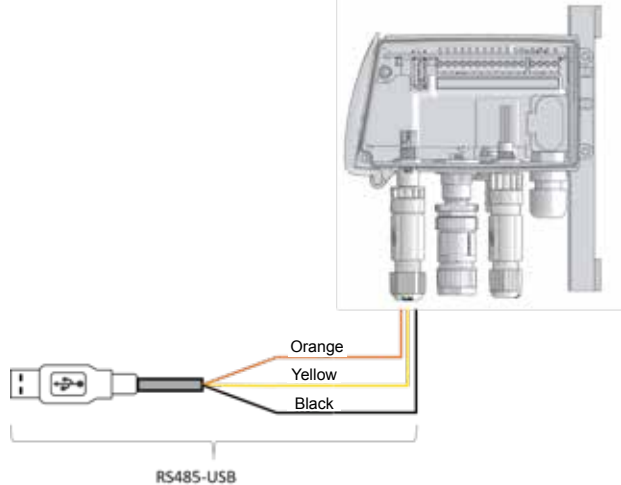

If the supplied length is not enough:

- identify the required wire length

⚠ We recommend that you contact an electrician or installer to install the required length of wire between your computer and the SmartDosing device.

⚠ Do not use a USB extension lead.

- connect the converter cable to a junction box, with the junction box connected to the required length of wire

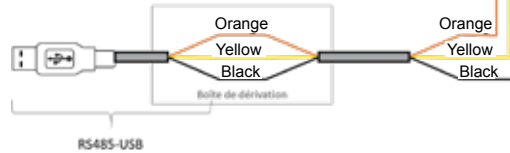

- connect the cable to the quick connector as explained above

- position the locating pin and screw the quick connector into the monitoring system

When connecting the cable, please observe the following cable specifications:

Twisted and shielded wire in accordance with EIA RS485

Resistance: 120 Ω / minimum cross-section 0.20mm²

If you need to connect more than one SmartDosing device to a single computer, we recommend the following layout:

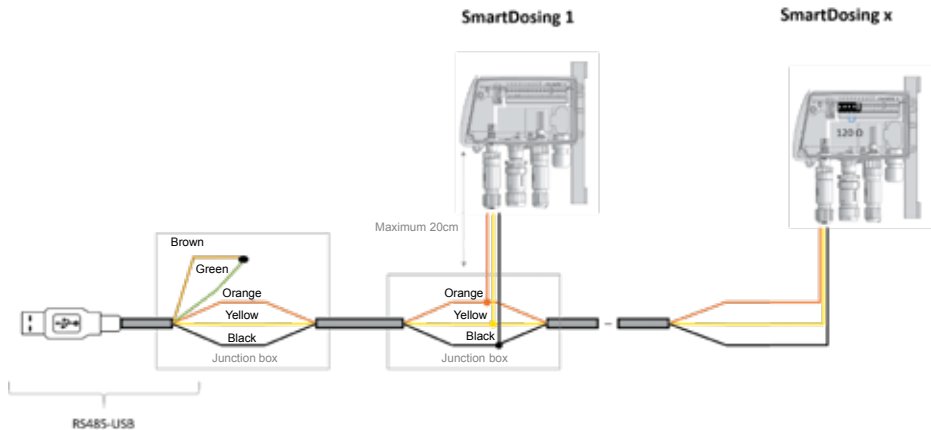

- use only one converter cable

 - remember that the resistance at the end of the line needs to be 120 Ω





 - remember to short-circuit the brown and green wires on the converter cable

When connecting the wire, please observe the following wire specifications:



Twisted and shielded wire in accordance with EIA RS485

Resistance: 120 Ω / minimum cross-section 0.20mm²

COMMUNICATION SETTINGS (MODBUS)

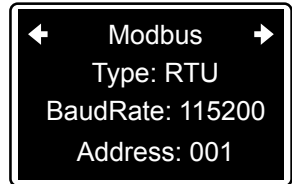
In the SETTINGS menu , press  or  to select the MODBUS sub-menu, then 



Press  until you reach the desired settings, then press  to move on to the next one.

Set the transmission type (RTU or ASCII), speed and address.

These settings must be taken into account when setting up the converter cable
(See INSTALLING THE SMARTLINK SOFTWARE)

 **If several devices are connected to the same converter, assign a different address to each one.**

CONNECTING TO A HOUSE CONTROLLER

We recommend that you contact your house controller supplier to ensure that your SmartDosing system is compatible with your controller type.

Do not use the cable supplied by Dosatron to make this connection; please use an RS485 cable that complies with the specifications indicated in the section above.

Installing the SmartLink software

Dosatron's SmartLink software is used to analyse the treatment data recorded by the SmartDosing system on a PC or MAC (treatment and dosing pump data).

REQUIREMENTS PRIOR TO INSTALLATION

Minimum requirements

- 2 Gb of RAM; 4 Gb recommended,
- 1 Gb of free hard drive space.
- minimum resolution: 1024 x 768.
- USB port - minimum 2.0

We recommend that you install the latest drivers for your graphics card, as well as the latest version of your anti-virus software.

Operating system

SmartLink software is a 32-bit Windows® / Mac OS application that runs on the following operating systems:

- Windows 10® x86 and x64
- Windows 8.1® x86 and x64
- Windows 7® x86 and x64
- Mac OS 10.X

You should use the latest service packs and critical updates for your version of Windows® / Mac OS.

Other requirements

- The hardware machine hosting the SmartLink software must be protected by an inverter.
- An automated backup system that complies with your Quality Management System (frequency, conservation period, etc.) ought to be in place.

SMARTLINK INSTALLATION

The SmartLink installation files are available on the USB key that comes with the SmartDosing device. Run the "Dosatron SmartLink" file, located in the USB key's SOFTWARE folder.

Follow the installation instructions.

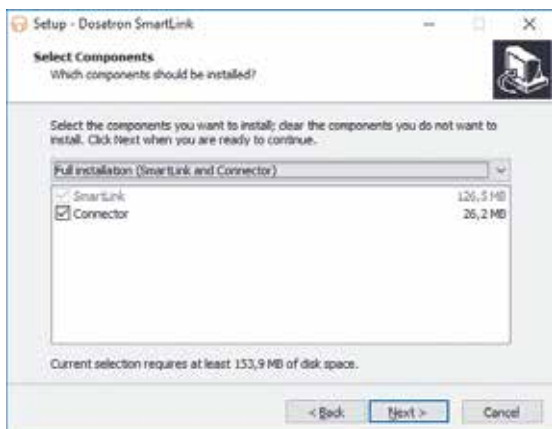
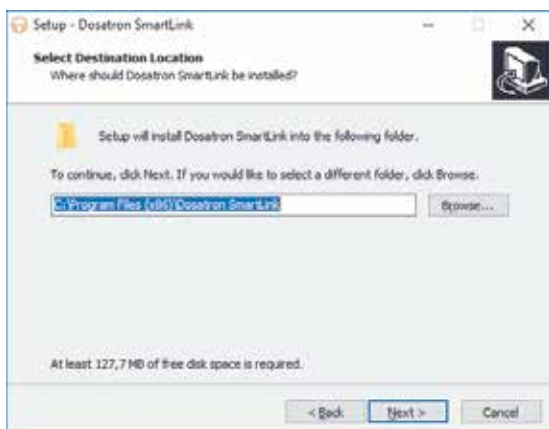
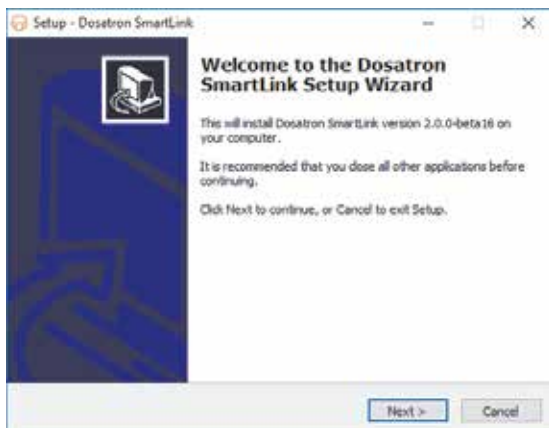

When connecting to a computer via the supplied converter cable, ensure that the 'Connector' box is marked with a tick. Otherwise, you can un-tick this box.

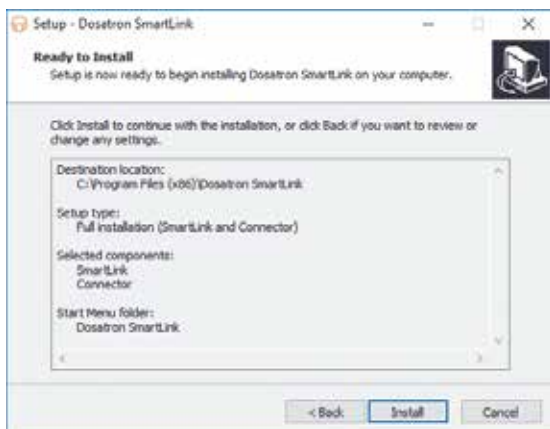
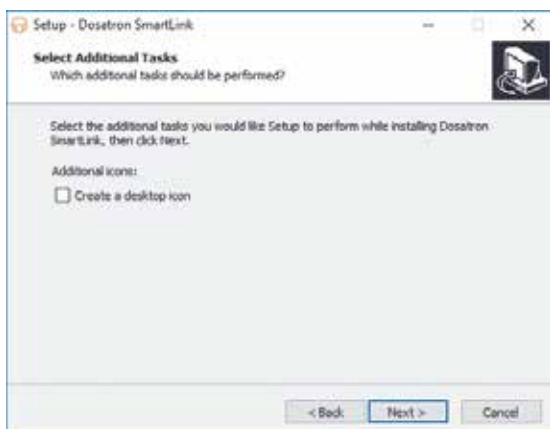
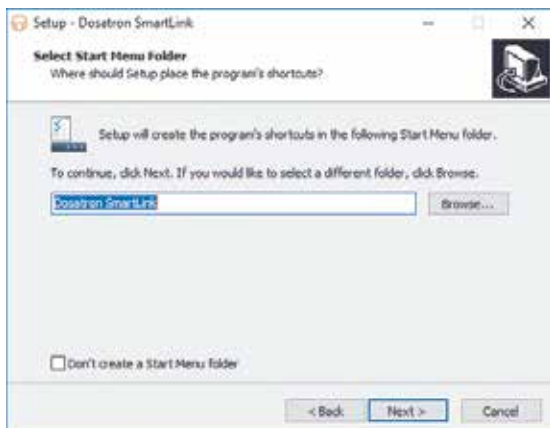

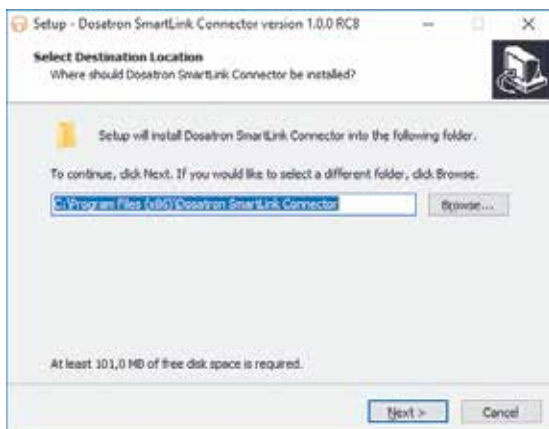
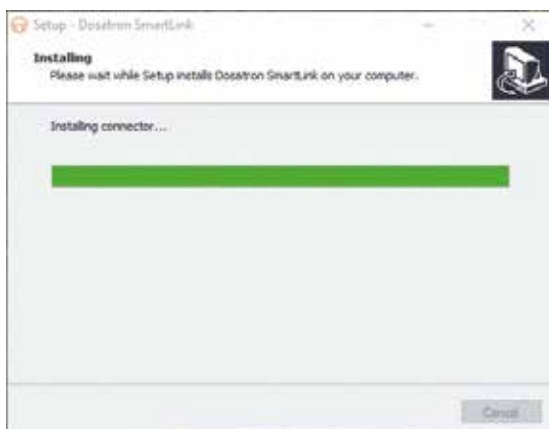
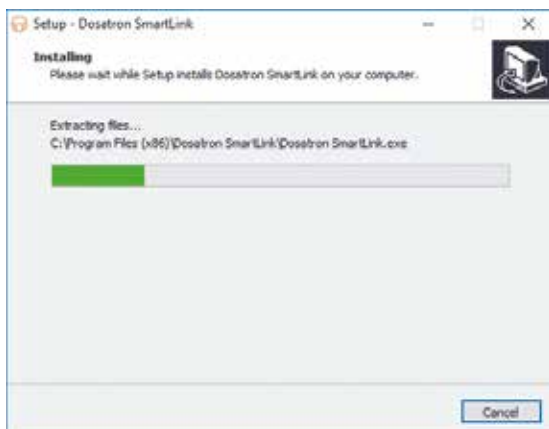

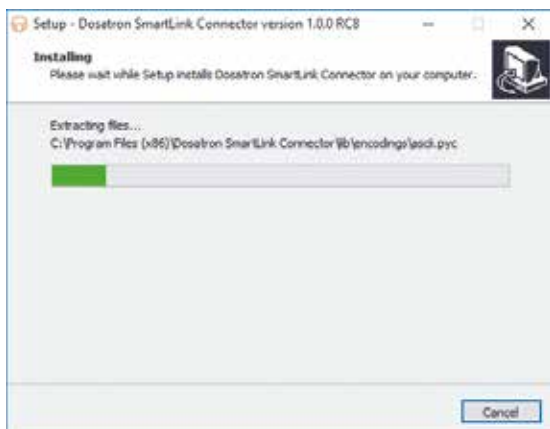
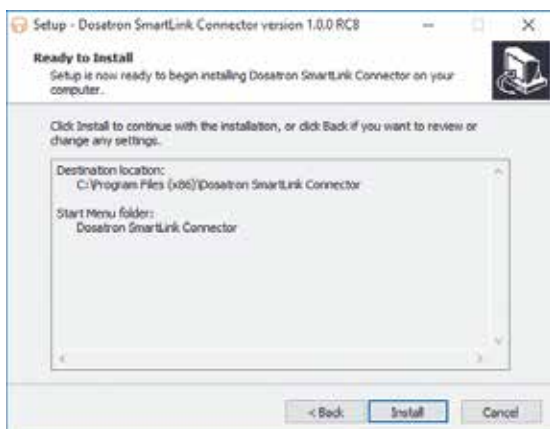
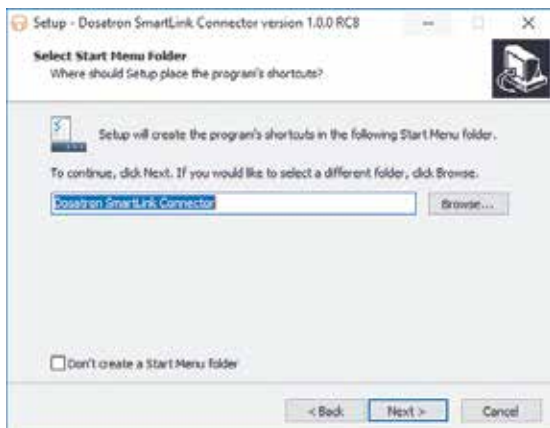

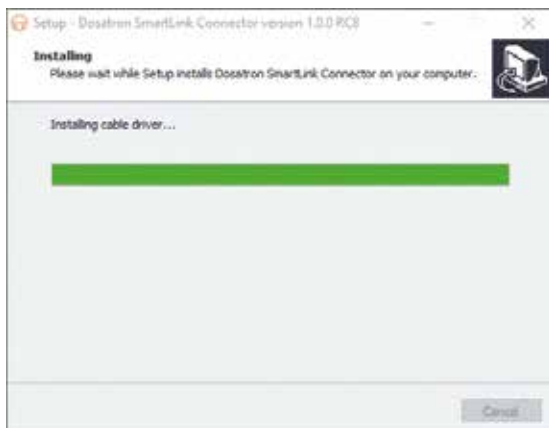

WHEN CONNECTING TO A COMPUTER

When installing the SmartLink software, if connecting to your computer, you will have the option to install the connector using the converter cable supplied by Dosatron.

Follow the installation instructions.



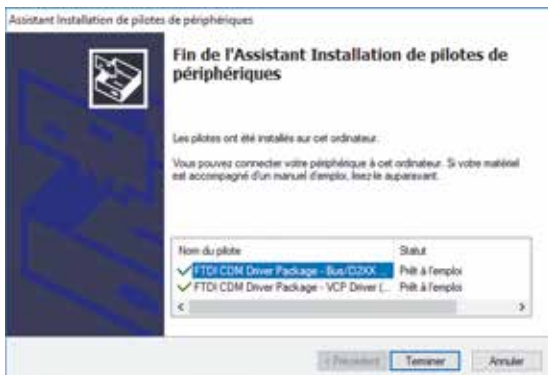
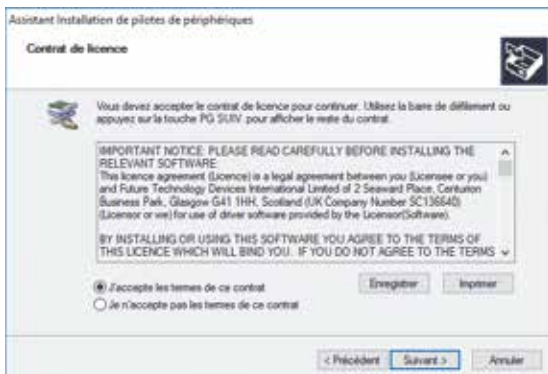
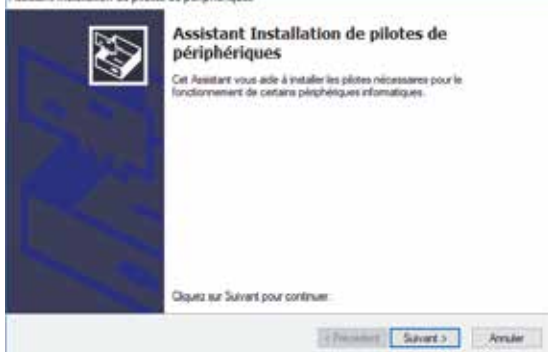

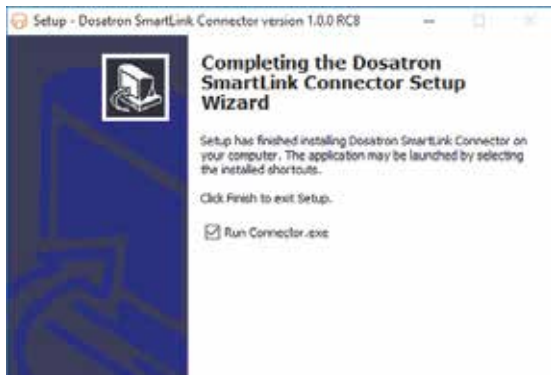

To select which connector (connection software) will automatically retrieve the SmartDosing data from the SmartLink, follow the on-screen instructions.

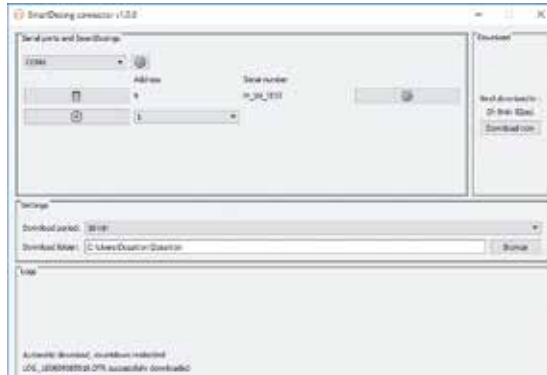

- Select the settings icon. A second page will open.

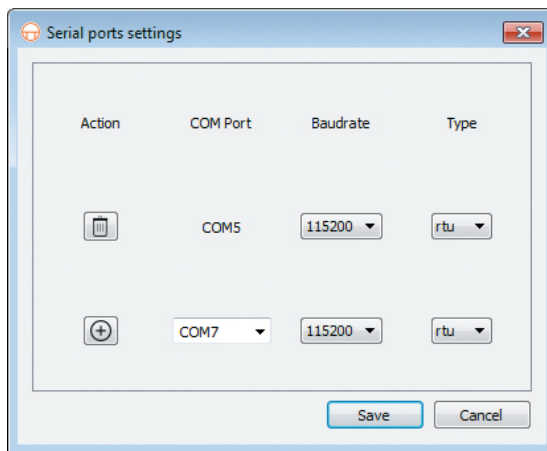

- Select the “COM port” for the converter cable which is connected to your computer, as well as the speed and type of your SmartDosing software
- If you have not changed the settings when setting up your SmartDosing system (see STARTING AND SETTING UP SMARTDOSING), simply select the “COM port”.
- Click on the + and then on “Save”.
- Select the address and click on +
- Your SmartDosing device is automatically set to address 1.

If a serial number is displayed, the setup has been successful. You can choose the software's automatic refresh time and then close the window. Setup is complete.

If the serial number is not displayed, repeat the procedure from when you selected the “COM port”.

Starting and setting up SmartLink

FEATURES AND USE

FIRST USE - IMPORTING DATA

When using for the first time, after reading and accepting the general terms and conditions of use, SmartLink will automatically prompt you to import the data. Insert the USB key into the computer's USB port. Click on 'Import'.



Select the USB key location and click on IMPORT again.



If SmartDosing is connected to the computer, the import will run automatically, within the time chosen when setting up the connector (See INSTALLING THE SMARTDOSING SOFTWARE).

To import new data via the USB key, select “import data” left side-menu of the “main menu”.

Follow the above procedure.

If new data is available for an existing or additional SmartDosing device, the following screen will be displayed.

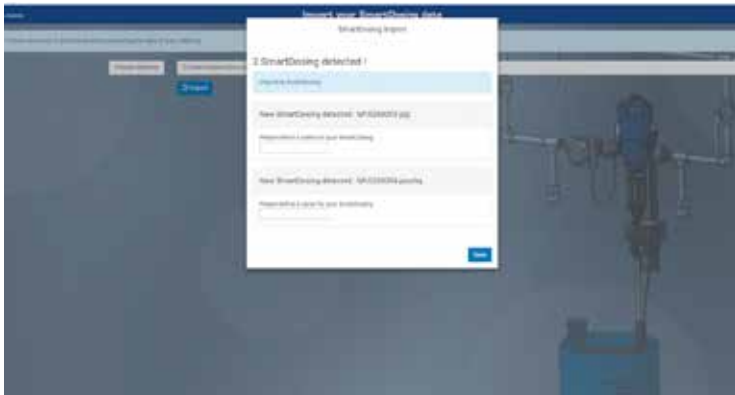

Enter a name for this new SmartDosing device and click on SAVE.

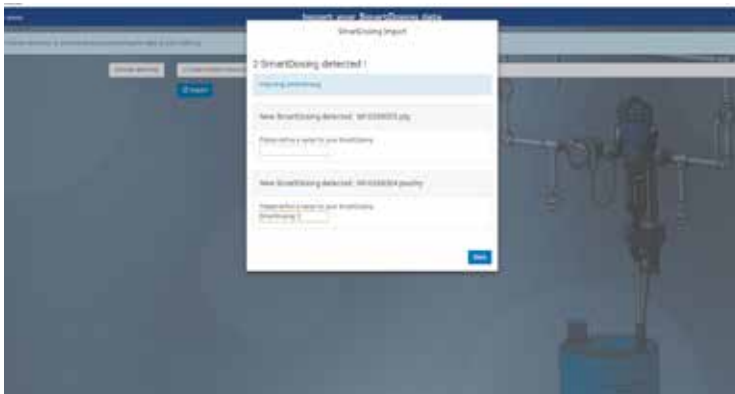

SmartLink will then save the data and automatically return to the dashboard.

DASHBOARD

The dashboard is displayed on the SmartLink software's home screen. A drop-down list at the top of the screen (on the left-hand side) can be used to select the desired SmartDosing device.

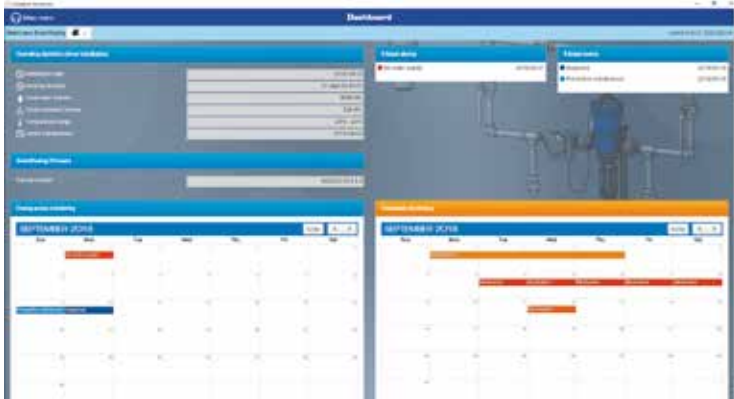

For each selected SmartDosing device, the SmartLink dashboard will provide a visual and accessible summary of all the recorded data:

- Name of the SmartDosing device and the date of the last data import.
- Performance statistics since its installation.
- A notification of the last 5 alarms and the last 5 events.
- The dosing pump's record calendar for alarms & events - from the dosing pump's monitoring system.
- Treatment record calendar - from the treatment monitoring system.

All of these functions are available in the dashboard's left side-menu, by clicking on "Main Menu" and selecting "Dashboard".

DOSING PUMP MONITORING

Information concerning the dosing pump's monitoring system can be accessed from the left side-menu, by clicking on "Main Menu".

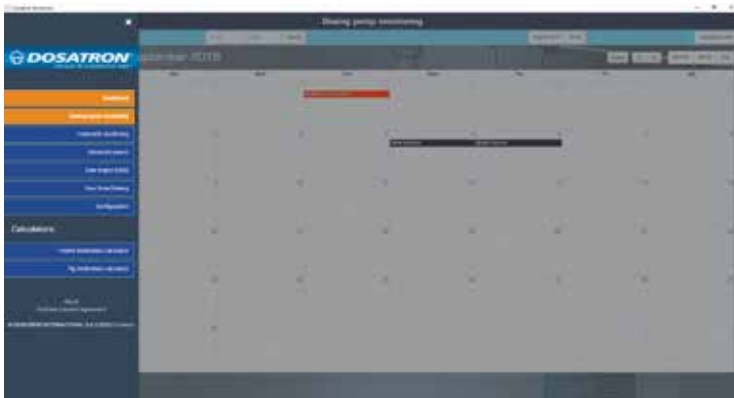

Select “Dosing pump monitoring”.

The calendar will automatically display the calendar month in which the last events or alarms were recorded. The event type is identified using colour coding.



Click on an event or alarm to see more details.

This information provides you with an indication of the details and possible causes of alarms as well as information concerning recorded events.

No water supply

Date: 2018/05/28 - 13:28:00

Details:
Possible cause(s):
- no water consumption on the part of the animals
- valves closed
- filter clogged
- interruption to the water supply

Close

Motor stopped

Date: 2019/09/04 - 15:07:52

Occurrences of the error: 1

Consequences: 9L water not treated

Details:
Motor stopped but the water is circulating
Close the pump by injecting clean water.
If the problem persists, make a diagnosis with the test tube.

Close

Diagnosis

Date: 2018/05/10 - 10:55:35

Details:
Engine OK
Injector OK

Close

Preventive maintenance

Date: 2018/06/09 - 07:43:00

Details:
Check the wear of your pump using the "diagnostic" menu and the graduated test tube.
Change the seals and the suction hose once a year.

Close

Backflow

Date: 2019/06/04 - 13:05:10

Details:
Abnormal rise in the level in the tank:
- do not fill the tank during treatment
- check there is no leak in the suction valve

Close

Overflow

Date: 2018/06/05 - 13:44:00

Details:
Instantaneous water flow higher than the maximum flow of the dosing pump.
- Check that there is not a leak from the drinking trough or a bleed of the pipes during the treatment.
If the problem persists use a Dosing pump with a higher capacity

Close

The bar at the top of the screen allows you to:

- select the desired SmartDosing device;
- identify specific dates to review the data over a given period of time;
- access the statistics provided by the dosing pump's monitoring system for that time period;
- create a PDF file or print the statistics file for that period.

To create a PDF file, click on EXPORT PDF, then follow the on-screen instructions to save the file in the desired location.

Follow the same instructions to view the statistics on-screen or print the statistics file.

If no custom date instruction is specified, the generated statistics concern all events for the entire period of use.

TREATMENT MONITORING

Information concerning the treatment's monitoring system can be accessed from the left side-menu, by clicking on "Main Menu".

Select "treatment monitoring"

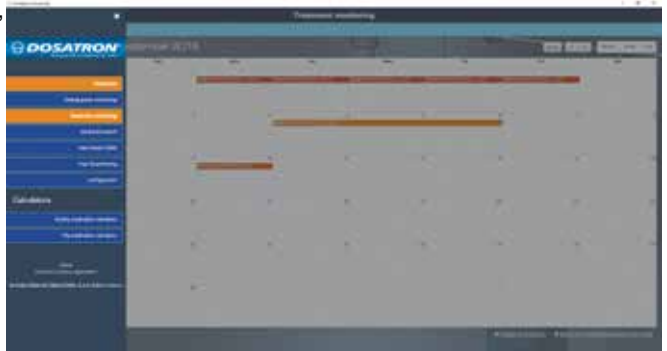

The calendar will automatically display the calendar month in which the last treatments were recorded. The treatment type is identified using colour coding.



Click on a treatment to display more details in the form of reports and graphs. The treatment details screen can be used to add information about the animals treated, the treatment administered, to add comments and to manage the display settings.



The form is divided into three horizontal sections. The top section contains several input fields with labels like 'Animal ID', 'Treatment ID', 'Date', 'Time', 'Dose', 'Frequency', and 'Duration'. The middle section has a few more input fields, possibly for 'Initial Value', 'Final Value', and 'Units'. The bottom section contains a few more input fields, including 'Start Date', 'End Date', and 'Status'. There are also some buttons and checkboxes visible.

ADVANCED SEARCH

Advanced search information can be accessed from the left side-menu, by clicking on “Main Menu”.



Select “Advanced search”



All your SmartDosing devices will be automatically selected.

Select the data you want to review (batch n°, hall n°, type of treatment, etc.) in order to display the treatments related to this data.

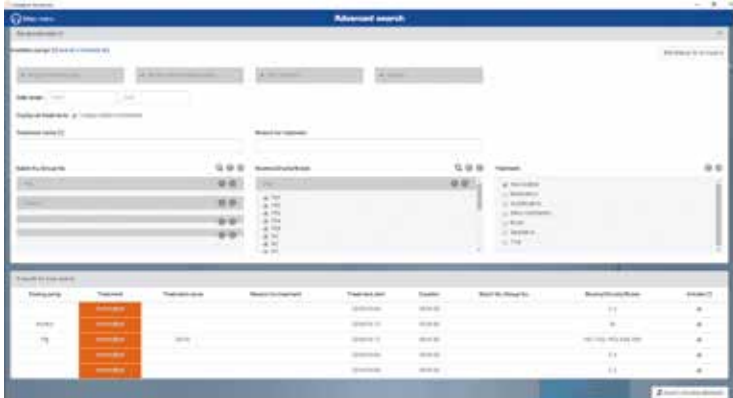

Select the results you want to save as a PDF file, export as a CSV file, or print out as per the procedure.

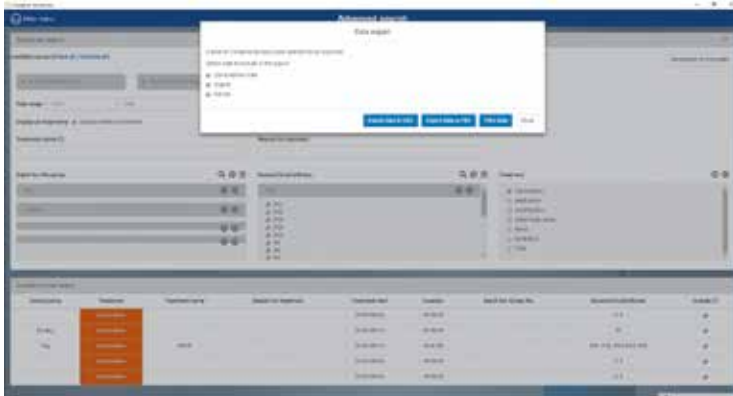

SETTINGS

YOUR SMARTDOSING DEVICES

Information concerning your SmartDosing devices can be accessed from the left side-menu, by clicking on “Main Menu”. Select “Your SmartDosing devices”.

Fill in the part number to access the information relating to your SmartDosing devices. To update your SmartDosing firmware, please refer to the UPDATES section.

GENERAL SETTINGS

SmartLink general settings information can be accessed from the left side-menu by clicking on “Main Menu” and then “Settings”.

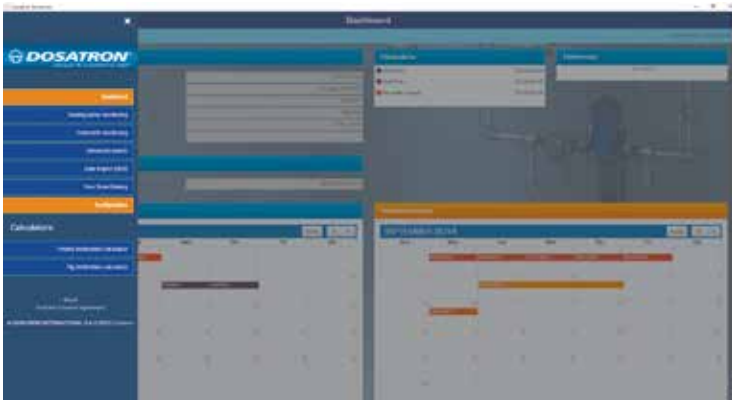

Enter the desired language, date format and units for the SmartDosing device.



To update the SmartLink, please refer to the UPDATES section.

Updates

SMARTDOSING UPDATES

In the SmartLink main menu, in the “Your SmartDosing devices” tab, you can see if there is an available update for your SmartDosing integrated software.

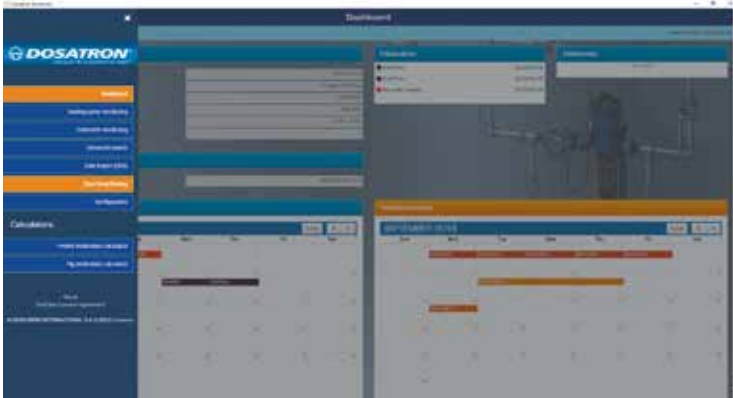

If an update is available, download the “download now” installation file onto the USB key.



Once the download is complete, close the SmartLink window.

Insert the USB key in the USB port on the right-hand side of the SmartDosing device; the data transfer screen will appear automatically.

Press ► to select the UPDATE icon, then to launch the update.

When the next screen is displayed a second time, the USB key can be removed.

You will then be returned to the home screen.

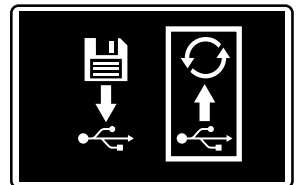

Important: the on-board software update keeps your previously recorded treatment & dosing pump data.

SMARTLINK UPDATES

In your SmartLink's main menu, select the "General Settings" tab.

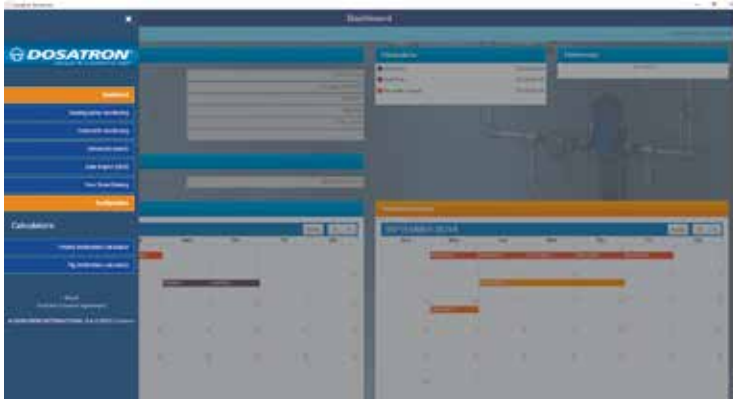

Your SmartLink's version number will be displayed.



You can also check for any available updates
If an update is available, download the "download now" installation file.



Once the download is complete, close the SmartLink window.
Open the file and follow the installation procedure.

Maintenance

When replacing the 9V battery, it is advisable to use the same battery type 9 Vdc - 500 mAh battery, model 6LR61.

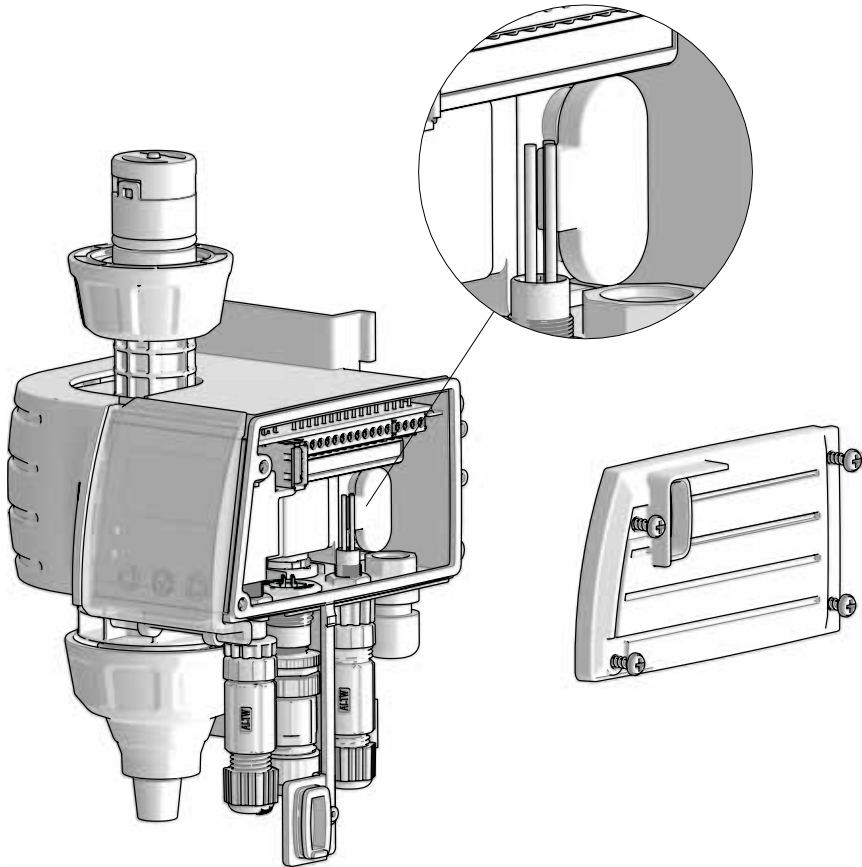

- Before and after replacing the 9V battery always keep the USB port cover closed to ensure that the monitoring system remains watertight.
- We recommend that you rinse the device with clear water after each use (using approx. 1 L / 0.264 US GALLONS).
- Carrying out a SmartDosing system diagnosis can help you to identify any problems with the motor or injection assembly whenever necessary (self-diagnosis program using a measuring cylinder sample).
- An annual service will extend the service life of your SmartDosing device. Replace the dosing seals and the suction hose/level detection pipe at least once a year.
- Ensure that the motor cycle counter is correctly fitted.

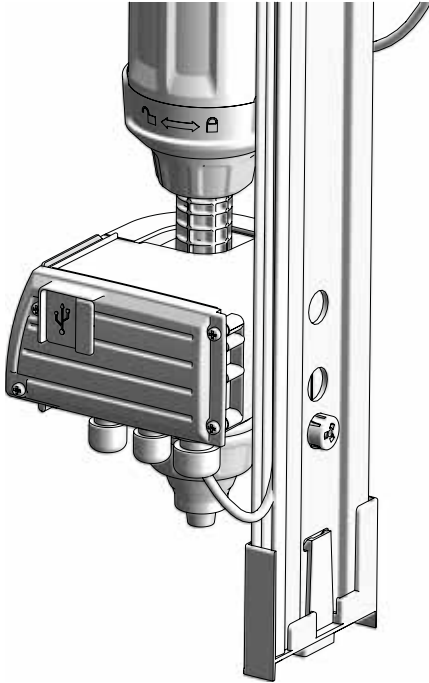

- Do not allow dust or particles to accumulate on the rail or between the rail and the monitoring system (the part of the mounting bracket behind the monitoring part of the system)

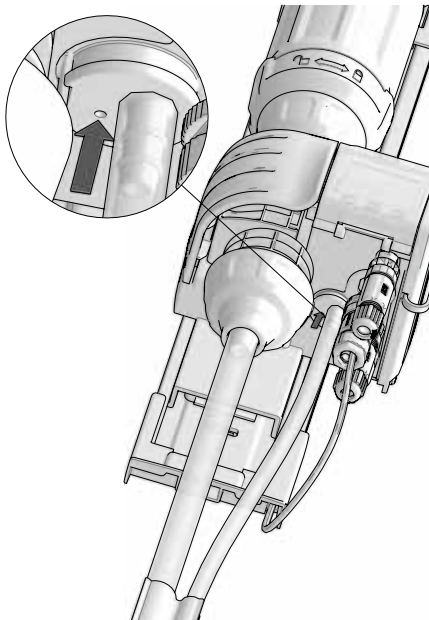

- Do not allow dust or particles to accumulate in the air pressure hole next to the level detection pipe

Troubleshooting

| SYMPTOM | CAUSE | SOLUTION |
|---|--|--|
| THE SCREEN DOES NOT LIGHT UP | The AC adapter is not connected to the mains supply | Connect the AC adapter to the mains supply |
| | The power supply cable quick connector is not properly connected to the monitoring system. | Check that it has been properly connected according to the connection procedure. |
| | The buttons have stopped working | Contact the distributor |
| THE SCALE SETTING READING IS INCORRECT | Indexing has not been carried out | Carry out the indexing procedure via the set up menu. Settings (see page 27) |
| | External elements are interfering with the scale reading | Make sure that the rail is clean |
| | The needle used to measure the dosing pump's position on the rail is defective or missing, see diagram on page 10. | Contact the distributor |
| LEAKS FOUND BETWEEN THE HYDRAULIC UNIT AND THE MONITORING SYSTEM. | The suction valve located between the hydraulic unit and the dosing pump is missing. (see diagram on page 10) | Install a suction valve |
| DURING A TREATMENT, THE WATER VOLUME INCREASE, BUT THE ADDITIVE AMOUNT REMAINS THE SAME. | I didn't reset the level at the start of the treatment (see page 30) | Reset the level at the start of the treatment |
| - and there's a false tank empty or a false low level signal | | |
| | There's an air leak on the level detection pipe | Check the level detection pipe connection. Check that the pipe is in the tank, and correctly positioned on the pipe guide at the right level in relation to the strainer. (See page 19). |
| - and there's an injection failure alarm as the tank level decreases. | | |
| | The lower suction valve is missing | Check to see if the lower suction valve is in place. |
| THE WATER LEVEL REMAINS CONSTANT AS THE DOSING PUMP SLAMS-ON AND THE TANK LEVEL DECREASES | The magnetic clip has become undone or damaged. | Check that the magnetic clip is in place and its condition; contact the distributor |
| - so I have motor faults when the dosing pump shuts down AND the level of additive in the tank goes down. | | |
| | The motor cycle counter quick connector is not properly connected to the monitoring system | Check that it has been properly connected according to the connection procedure. |
| | The motor cycle sensor has become dislodged, damaged or disconnected | Check the position of the motor cycle sensor; check the integrity of the wire; check its connection to the terminal board. |

| | | |
|---|---|---|
| MOTOR STOP ALARM | | |
| - If on the 10% discrepancy display the water meter value = 0 | | |
| | The water meter is the wrong way round or not working | Return the meter to the proper position or replace it |
| | The water meter's pulse meter is broken, not connected to the water meter, or disconnected from the terminal board of the monitoring system | Reconnect it or change it |
| - If on the 10% discrepancy display the water meter value = less than the reed switch value | | |
| | The water meter's pulse meter battery is almost discharged | Change the water meter's pulse meter |
| | The water meter is worn out | Replace the water meter |
| - If my dosing pump fails to prime correctly | | |
| | Refer to the dosing pump's instruction manual | |
| | The hydraulic unit's insulation seal is missing or damaged. (see diagram on page 10) | Check that the joint is in place and its condition. Clean, replace or refit |
| I HAVE A BACKFLOW ALARM BUT THE TANK LEVEL DOES NOT INCREASE VERY MUCH (LESS THAN 4CM) | There's an air leak on the level detection pipe | Check the level detection pipe connection. Check that the pipe is in the tank, and correctly positioned on the pipe guide at the right level in relation to the strainer. |
| | The monitoring unit heats up | Limit exposure to sunlight or intermittent heat sources |
| | The pipes are not well connected and/or have become unsealed at the bottom of the tank. | Make sure that the 2 hoses are held in place at the bottom of the tank. |
| RECOVERING DATA OR UPDATING THE SMARTDOSING VIA THE USB KEY ENDS WITH A SYSTEM ERROR | The USB key is broken | Change the USB key |
| | The update is not stored in the right place on the USB key | Repeat the update procedure |
| | I removed my USB key before the end of the process at the bottom of the tank. | Confirm the screen and start again |
| | | If problem persists, please contact the distributor |
| A "SYSTEM ERROR" OCCURS AT THE BEGINNING OF A RECORDING OR DURING THE RECORDING | There is a problem with the internal memory | Contact the distributor |
| THE CONVERTER CABLE CANNOT RETRIEVE THE DATA | The quick connector is not properly connected to the monitoring system. | Check that it has been properly connected according to the <u>connection procedure</u> . |
| | The computer software has not been installed or set up correctly | Check that it has been installed and set up according to the installation procedure. |

**DOSATRON INTERNATIONAL
DOES NOT ACCEPT LIABILITY FOR ANY DAMAGE
RESULTING FROM IMPROPER USE.**

Warranty

DOSATRON INTERNATIONAL S.A.S. undertakes to replace any original part deemed as defective within a period of twelve months for the “dosing” part of the SD25AL5 system, and within a period of twenty-four months for the “monitoring module” part of the system, starting from the date on which it was purchased by the initial purchaser.

To obtain a warranty replacement, the device or spare part must be returned to the manufacturer or authorized distributor along with the original proof of purchase.

Defects will only be acknowledged following an assessment carried out by the manufacturer’s or distributor’s technical services.

The device must be rinsed and free of any chemicals, and sent to the manufacturer or distributor via prepaid shipping, and will be returned free of charge once the repair has been completed, providing it is covered by the warranty.

Services rendered under the warranty cannot extend the duration thereof.

This warranty applies only to manufacturing defects.

This warranty does not cover any defects resulting from abnormal installation, the

use of unauthorized tools, incorrect installation, improper maintenance, environmental accidents, or corrosion caused by foreign objects or liquids found in or near the device.

For dosing aggressive products, please contact your distributor before using the product, in order to ensure that it is compatible with the dosing pump.

This warranty does not cover seals (wearing parts) or any damage caused by water impurities, such as sand. A filter (e.g. 300 mesh - 60 microns, depending on your water quality) must be installed ahead of the device for this warranty to be valid.

DOSATRON INTERNATIONAL S.A.S. declines all responsibility if the device is used in conditions that do not comply with the requirements and tolerances specified in the user manual.

There is no express or implied warranty with respect to other products or accessories used in conjunction with DOSATRON INTERNATIONAL S.A.S. devices.

Do not hesitate to call your distributor or DOSATRON for any after-sales services.

This document does not form a contractual engagement and is for information purposes only.
DOSATRON INTERNATIONAL S.A.S. reserves the right to modify its devices at any time

CE Conformity Statement

Document N° DOCESD190901

This Dosatron is in compliance with the European Directive 2006/42/CE.

This declaration is only valid for countries of the European Community (CE).